

Series 343

Granville-Phillips® Mini-Ion™ Vacuum Gauge Module with RS-485 Digital Interface



Instruction Manual

Instruction manual part number 343048

Revision B - November 2016

Series 343

Granville-Phillips® Mini-Ion™ Vacuum Gauge Module with RS-485 Digital Interface

This instruction manual is for use with Mini-Ion
Module catalog number 343033-EU.



Customer Service / Technical Support:

MKS Pressure and Vacuum Measurement Solutions

MKS Instruments, Inc., Granville-Phillips® Division
6450 Dry Creek Parkway
Longmont, Colorado 80503 USA
Tel: 303-652-4400
Fax: 303-652-2844
Email: mks@mksinst.com

MKS Corporate Headquarters

MKS Instruments, Inc.
2 Tech Drive, Suite 201
Andover, MA 01810 USA
Tel: 978-645-5500
Fax: 978-557-5100
Email: mks@mksinst.com

Instruction Manual

Table of Contents

Safety	1-5
Safety Instructions.....	1-5
Chapter 1 Introduction	1-9
1.1 General Description	1-9
1.2 Specifications	1-9
1.3 Power Supply Requirements	1-11
1.4 Component Description.....	1-11
1.4.1 Input/Output Connector.....	1-11
1.4.2 Power Indicator Lamp	1-12
1.4.3 Address Selector Switch.....	1-12
1.5 Theory of Operation	1-12
1.6 Emission Current	1-13
1.7 Overpressure Shutdown.....	1-13
1.8 Degas Cycle	1-13
1.9 Customer Service / Technical Support	1-14
Chapter 2 Installation and Configuration	1-15
2.1 Grounding.....	1-15
2.2 I/O Cable Connections	1-16
2.3 Installation.....	1-16
2.3.1 Firmware Configuration.....	1-17
2.4 Resetting Data Communication Parameters	1-18
2.5 Calculating a Gas Sensitivity Correction	1-19
2.6 Very-High and Ultra-High Vacuum Measurement	1-20
2.6.1 Mini-Ion Vacuum Gauge Module for Process Chamber Baking	1-20
Chapter 3 RS-485 Digital Interface Specifications and Protocol	1-23
3.1 Interface Configuration	1-23
3.2 Command Syntax	1-23
3.2.1 Command Descriptions	1-23
3.3 Receive/Transmit Timing	1-29
Chapter 4 Service and Maintenance	1-31
4.1 Service Guidelines.....	1-31
4.2 Damage Requiring Service.....	1-31
4.3 Troubleshooting.....	1-32
4.4 Mini-Ion Vacuum Gauge Module Ion Gauge Continuity Test.....	1-33
4.5 Mini-Ion Vacuum Gauge (with Digital Interface) Module Initialization	1-35
4.5.1 Initialization	1-35
4.6 Degas Cycle	1-36
4.6.1 Digital Interface.....	1-37
4.7 Fuse Replacement	1-37
4.8 Mini-Ion Vacuum Gauge Module Replacement.....	1-38
4.9 Customer Service / Technical Support	1-40

Safety Instructions

START BY READING THESE IMPORTANT SAFETY INSTRUCTIONS AND NOTES collected here for your convenience and repeated with additional information at appropriate points in these instructions.

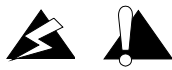

These safety alert symbols in this manual or on the Product rear panel, mean caution – personal safety, property damage or danger from electric shock. Read these instructions carefully.

In these instructions the word “product” refers to the Mini-Ion Vacuum Gauge Module and all of its approved parts and accessories.

NOTE: These instructions do not and cannot provide for every contingency that may arise in connection with the installation, operation, or maintenance of this product. If you require further assistance, contact MKS, Granville-Phillips Division at the address on the title page of this manual.

This product was designed and tested to offer reasonably safe service provided it is installed, operated, and serviced in strict accordance with these safety instructions.



Failure to comply with these instructions may result in serious personal injury, including death, or property damage.

These safety precautions must be observed during all phases of operation, installation, and service of this product. Failure to comply with these precautions or with specific warnings elsewhere in this manual violates safety standards of design, manufacture, and intended use of the instrument. MKS Instruments, Inc. disclaims all liability for the customer's failure to comply with these requirements.



The service and repair information in this manual is for the use of Qualified Service Personnel. To avoid electrical shock, do not perform any procedures in this manual or perform any servicing on this product unless you are qualified to do so.

- *Read Instructions* – Read all safety and operating instructions before operating the product.
- *Retain Instructions* – Retain the Safety and Operating Instructions for future reference.
- *Heed Warnings* – Adhere to all warnings on the product and in the operating instructions.
- *Follow Instructions* – Follow all operating and maintenance instructions.
- *Accessories* – *Do not* use accessories not recommended in this manual as they may be hazardous.



To reduce the risk of fire or electric shock, do not expose this product to rain or moisture.



Objects and Liquid Entry – Never push objects of any kind into this product through openings as they may touch dangerous voltage points or short out parts that could result in a fire or electric shock. Be careful not to spill liquid of any kind onto the products.

	<p>Do not substitute parts or modify instrument.</p> <p>Because of the danger of introducing additional hazards, do not install substitute parts or perform any unauthorized modification to the product. Return the product to a service facility designated by Granville–Phillips for service and repair to ensure that safety features are maintained. Do not use this product if it has unauthorized modifications.</p>
---	--

Damage Requiring Service

Disconnect the product from all power sources and refer servicing to Qualified Service Personnel under the following conditions:

- a. When any cable or plug is damaged.
- b. If any liquid has been spilled onto, or objects have fallen into, the product.
- c. If the product has been exposed to rain or water.
- d. If the product does not operate normally even if you follow the operating instructions. Adjust only those controls that are covered by the operation instructions. Improper adjustment of other controls may result in damage and will often require extensive work by a qualified technician to restore the product to its normal operation.
- e. If the product has been dropped or the enclosure has been damaged.
- f. When the product exhibits a distinct change in performance. This indicates a need for service.

	<p>Replacement Parts – When replacement parts are required, be certain to use the replacement parts that are specified by Granville–Phillips, or that have the same characteristics as the original parts. Unauthorized substitutions may result in fire, electric shock or other hazards.</p>
---	---

	<p>Safety Check – Upon completion of any service or repairs to this product, ask the Qualified Service Person to perform safety checks to determine that the product is in safe operating order.</p>
---	---

	<p>Finite Lifetime – After ten years of normal use or even non–use, the electrical insulation in this product may become less effective at preventing electrical shock. Under certain environmental conditions which are beyond the manufacturer’s control, some insulation material may deteriorate sooner. Therefore, periodically inspect all electrical insulation for cracks, crazing, or other signs of deterioration. Do not use if the electrical insulation has become unsafe.</p>
---	--

	<p>Be aware that when high voltage is present in any vacuum system, a life threatening electrical shock hazard may exist unless all exposed conductors are maintained at earth ground.</p> <p>This hazard is not peculiar to this product.</p>
---	--

	<p>Be aware that an electrical discharge through a gas may couple dangerous high voltage directly to an ungrounded conductor almost as effectively as would a copper wire connection. A person may be seriously injured or even killed by merely touching an exposed ungrounded conductor at high potential.</p> <p>This hazard is not unique to this product.</p>
---	--

Proper Grounding:

All components of a vacuum system used with this or any similar high voltage product must be maintained at earth ground for safe operation. Be aware that grounding this product does not guarantee that other components of the vacuum system are maintained at earth ground.

Verify that the vacuum port to which the Mini-Ion Module is mounted is electrically grounded. It is essential for personnel safety as well as proper operation that the envelope of the gauge be connected to a facility ground. Use a ground lug on a flange bolt if necessary.



All conductors in, on, or around the vacuum system that are exposed to potential high voltage electrical discharges must either be shielded at all times to protect personnel or must be connected to earth ground at all times.



Danger, High Voltage – The high voltages present within the Power Supply are capable of causing injury or death. To avoid electric shock, wait 3 minutes after power is removed before touching any component within the Power Supply. This will permit charged capacitors to discharge.



Danger, high voltage – 180V is present in the Power Supply, on the cable, and at the ion gauge when the gauge is turned on. Voltages as high as 250V peak are present during degas.



Install suitable devices that will limit the pressure to the level that the vacuum system can safely withstand. In addition, install suitable pressure relief valves or rupture disks that will release pressure at a level considerably below the pressure that the system can safely withstand.

Suppliers of pressure relief valves and pressure relief disks can be located via an online search, and are listed on ThomasNet.com under “Relief Valves” and “Rupture Discs. *Confirm that these safety devices are properly installed before installing and operating the product.*

Ensure the following precautions are complied with at all times:

- (1) the proper gas cylinders are installed,
- (2) the gas cylinder valve positions are correct on manual systems,
- (3) and the automation is correct on automated gas delivery systems.

Vacuum gauges with compression fittings may be forcefully ejected if the vacuum system is pressurized.



Caution: If the overpressure shutdown point is increased from the factory settings, an excess pressure rise may go undetected—resulting in possible gauge and/or vacuum system damage. Consult the factory if in doubt.

It is the installer's responsibility to ensure that the automatic signals provided by the product are always used in a safe manner. Carefully check manual operation of the system and the set point programming before switching to automatic operation.

Where an equipment malfunction could cause a hazardous situation, always provide for fail-safe operation. As an example, in an automatic backfill operation where a malfunction might cause high internal pressures, provide an appropriate pressure relief device.

Notes:

Introduction

1.1 General Description

The Mini-Ion Vacuum Gauge Module, shown in Figure 1-1, is a modular instrument that measures vacuum pressures from less than 5×10^{-8} Torr to 5×10^{-2} Torr, N_2 equivalent (or air). The Mini-Ion Vacuum Gauge Module does not have external controls or adjustments and is available in RS-485 digital interface and analog versions.

The Mini-Ion Vacuum Gauge Module is a small rugged unit that has a wider measurement range, more burnout resistance and generates less heat than typical glass gauges. Additional benefits include:

- Compact, Convenient, Cost Saving Vacuum Measurement
- Rapid response during Pumpdown
- Cooler Operation
- Easy Compatibility with Computer Controlled Processes

The RS-485 digital interface version provides industry-standard digital RS-485 communications over networks as well as direct connections to a personal computer. The setpoint relay, filament, and degassing of the gauge tube can be easily selected via the RS-485 digital interface.

The setpoint relay can be used to control various devices such as; safety interlock, valve, digital input for a scanner, or programmable logic controller. The setpoint relay trip points can be set to customized pressure settings to turn power ON or OFF to the appropriate device.

1.2 Specifications

Refer to Figure 1-1 for the dimensions of the Mini-Ion Vacuum Gauge Module with RS-485 Digital Interface.

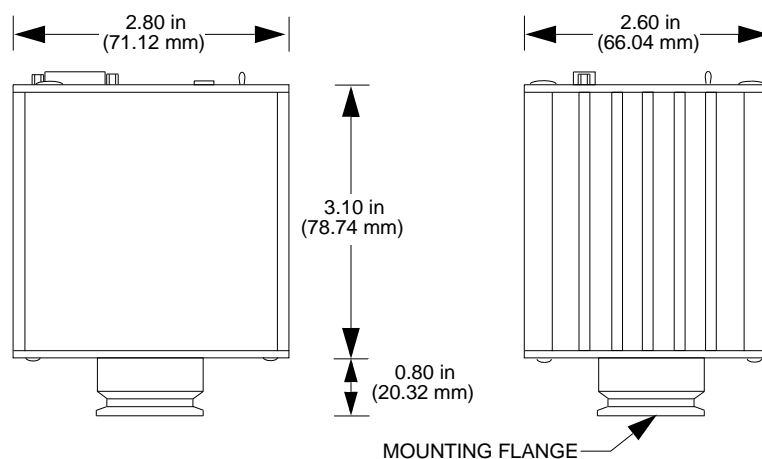

Figure 1-1 Mini-Ion Vacuum Gauge Module Dimensions

Refer to Tables 1-1 and 1-2 for performance and physical specifications of the Mini-Ion Vacuum Gauge Module. Refer to Table 1-3 for RS-485 communication parameters.

Table 1-1 Performance Specifications

Parameter	Specification
Measurement Range	5 x 10 ⁻⁸ to 5 x 10 ⁻² Torr for N ₂ or air NOTE: For use below 1 x 10 ⁻⁷ Torr, the use of a metal seal is recommended.
Overpressure Protection	Gauge tube turns off if pressure rises above 5 x 10 ⁻³ Torr
Emission Current	100 μA, 2mA
Operating Voltage and Power	+24 Vdc, ±15%, 0.5 Amperes, 12 Watts maximum NOTE: Customer supplied power supply
Degas	Electron bombardment, approximately 2.5 watts with 2 minute timer
Setpoint Relay	Single pole-double throw relay (SPDT) Silver alloy-gold clad contacts 1A, 30 Vdc, resistive load or AC non-inductive

Table 1-2 Physical Specifications

Parameter	Specification
Vacuum Connections	O-ring - NW16KF flange
Electrical Connection	9 pin D connector
Weight	13 oz.
Case Material	Aluminum extrusion
Gauge Tube Replacement	Field replaceable using only Phillips-type screwdriver
Electrical Safety	Metal enclosure which houses 180 V supply will require use of a metal flange clamp to assure ground continuity to system.
Compliance EMC Directive Low Voltage Directive	2004/108/EC; EN61326-1 2006/95/EC; EN61010-1
IP Rating	IP20
Operating Temp Range	0 °C to 40 °C
Non-operating Temp Range	-40 °C to 70 °C

Table 1-3 RS-485 Communication Parameters

Parameter	Default Value	Range of Values
Baud Rate	19,200	300, 600, 1200, 2400, 4800, 9600, 14,400, 19,200, 28,000
Data Format	8 bits	7 - 8
Parity	None	none, even, odd
Stop Bits	1	N/A

1.3 Power Supply Requirements

The customer supplied power supply should provide operating voltage and current to the Mini-Ion Vacuum Gauge Module as specified in Table 1-1.

1.4 Component Description

The top plate of the Mini-Ion Vacuum Gauge Module with RS-485 Digital Interface is shown in Figure 1-2 and described in the following paragraphs.

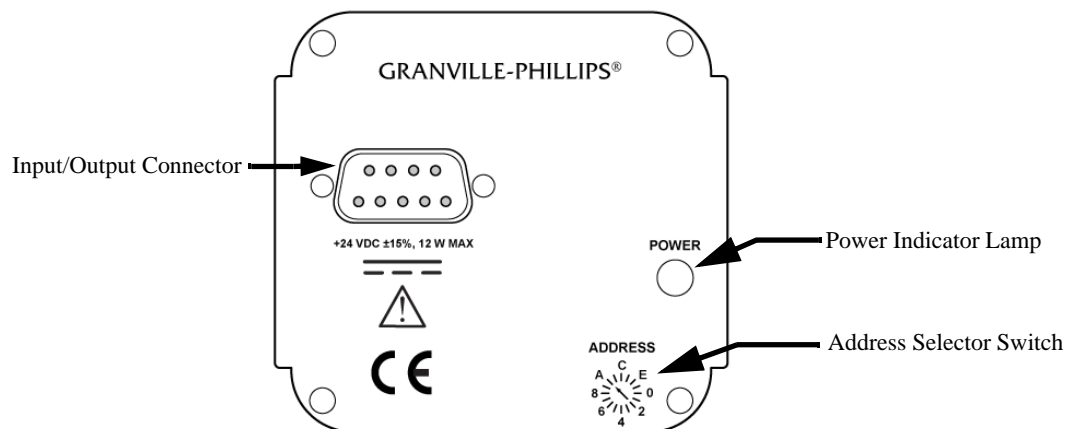

Figure 1-2 Mini-Ion Vacuum Gauge Module Top Plate

1.4.1 Input/Output Connector

The Input/Output Connector provides a connection to the Mini-Ion Vacuum Gauge Module for 24 Vdc Input power and various gauge signals. Refer to Figure 1-3 for pin assignments.

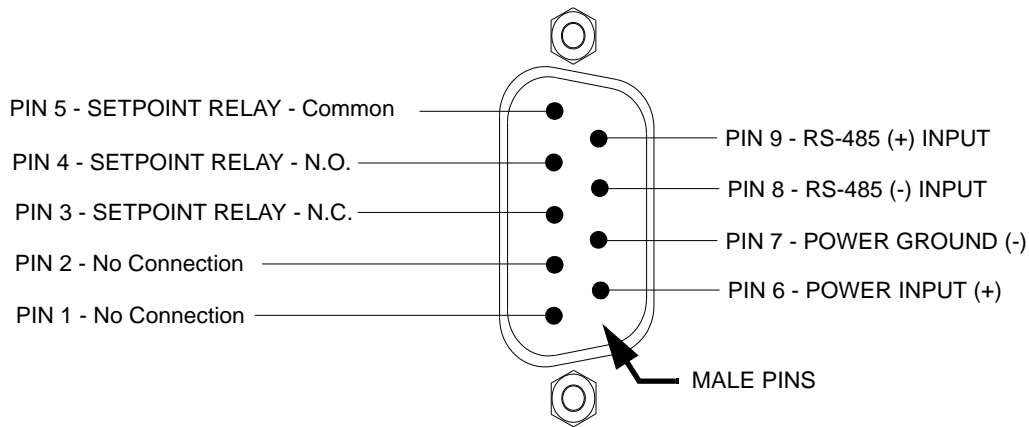

Figure 1-3 Mini-Ion Vacuum Gauge Module Input/Output Connector Pin Assignments

1.4.2 Power Indicator Lamp

The Power Indicator lamp illuminates RED when power is applied and ion gauge is OFF; GREEN when ion gauge is ON.

1.4.3 Address Selector Switch

The Address Selector Switch determines the network address for the Mini-Ion Vacuum Gauge Module. The switch position must be set to the appropriate network address for each Mini-Ion Vacuum Gauge Module on the network.

1.5 Theory of Operation

The functional parts of a typical ionization gauge are the filament (cathode), grid (anode) and ion collector, which are shown in Figure 1-4. These electrodes are maintained by the gauge controller at +30, +180, and 0 volts, relative to ground, respectively.

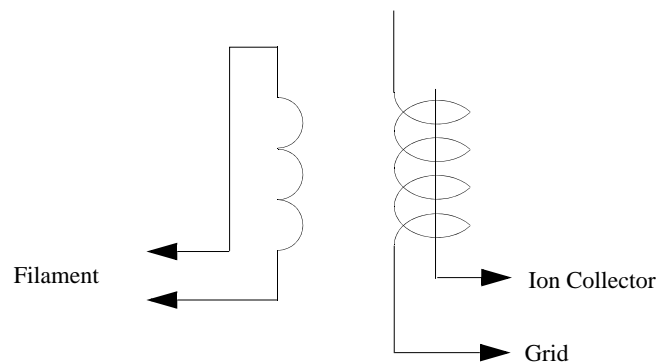

Figure 1-4 Ion Gauge Schematic

The filament is heated to such a temperature that electrons are emitted, and accelerated toward the grid by the potential difference between the grid and filament. Most of the electrons eventually collide with the grid, but many first traverse the region inside the grid many times.

When an energetic electron collides with a gas molecule an electron may be dislodged from the molecule leaving it with a positive charge. Most ions are then accelerated to the collector.

The rate at which electron collisions with molecules occur is proportional to the density of gas molecules, and hence the ion current is proportional to the gas density (or pressure, at constant temperature).

The amount of ion current for a given emission current and pressure depends on the ion gauge design. This gives rise to the definition of ion gauge *sensitivity*, frequently denoted by *K*:

$$K = \text{ion current}/(\text{emission current} \times \text{pressure})$$

When used with nitrogen or air, the Mini-Ion Vacuum Gauge Module has a sensitivity of 5.2/Torr. Refer to Chapter 2, Introduction, for more information.

The Mini-Ion Vacuum Gauge Module controller varies the heating current to the filament to maintain a constant electron emission, and measures the ion current to the collector. The pressure is then calculated from these data.

The Mini-Ion Vacuum Gauge Module degas cycle is accomplished by increasing the emission current to 10 mA resulting in an increased temperature of the grid to drive off adsorbed gas.

1.6 Emission Current

There are two ranges of emission current available. Either 100 microamperes or 2 milliamperes are available as determined by the digital interface. While either range can be used continuously, the following guidelines are suggested. For operation in the higher pressure ranges with a clean system 100 microamperes emission is satisfactory. This will give a theoretical longer filament life and allows usage to where the gauge pressure reading overlaps with other type transducers such as the Convector or capacitance manometer. For operation in the lower pressure ranges the 2 milliampere range should be used to give a more accurate pressure reading.

Internal circuitry corrects the pressure output data for the emission current selected. There is a problem with all ion gauges when used in systems which have the potential for diffusion pump oil vapor to enter the gauge tube.

This oil vapor deposits on the grid forming an insulator and preventing emission resulting in higher and higher filament power being required and ultimate inability to control emission. In this situation the 2 milliampere position is recommended.

1.7 Overpressure Shutdown

Overpressure shutdown is programmable by use of the computer interface. This is preset at 5×10^{-3} Torr.

1.8 Degas Cycle

Pump oil, other organic compounds, or metal coatings from a sputtering process can cause electrical current leakage between the ion gauge tube elements. When contamination occurs, system base pressure readings may begin to rise which is an indication that a degas cycle will have to be performed.

The removal of gas from the gauge tube is accomplished by electron bombardment (EB) heating of the grid. Pressure reading during a degas cycle is provided. Note that in order to activate the degas circuit, the IG ON circuit must be first activated. This assures that there is a vacuum in the system prior to the degas cycle. Also note that the degas circuit will turn off if the IG ON circuit is turned off.

Due to the small size of the gauge, power during a degas cycle is approximately 2.5 watts above operating power and is turned OFF automatically after a two minute period.

Refer to Section 4.6 for more information on performing a degas cycle.

1.9 Customer Service / Technical Support

Some minor problems are readily corrected on site. If the product requires service, contact the MKS/Granville-Phillips Technical Support Department at 1-303-652-4400 for troubleshooting help over the phone.

If the product must be returned to the factory for service, request a Return Material Authorization (RMA) from Granville-Phillips. Do not return products without first obtaining an RMA. In some cases a hazardous materials disclosure form may be required. The MKS/Granville-Phillips Customer Service Representative will advise you if the hazardous materials document is required.

When returning products to Granville-Phillips, be sure to package the products to prevent shipping damage. Shipping damage on returned products as a result of inadequate packaging is the Buyer's responsibility.

For Customer Service / Technical Support:

MKS Pressure and Vacuum Measurement Solutions

MKS Instruments, Inc., Granville-Phillips® Division

6450 Dry Creek Parkway

Longmont, Colorado 80503 USA

Tel: 303-652-4400

Fax: 303-652-2844

Email: mks@mksinst.com

MKS Corporate Headquarters

MKS Instruments, Inc.

2 Tech Drive, Suite 201

Andover, MA 01810 USA

Tel: 978-645-5500

Fax: 978-557-5100

Email: mks@mksinst.com

Installation and Configuration

This chapter provides the information required to install the RS-485 digital interface version of the Mini-Ion Vacuum Gauge Module.

The flowchart in Figure 2-1 highlights the major tasks for installing the Mini-Ion Vacuum Gauge Module (with RS-485 digital interface) and refers to the appropriate installation procedures within this chapter.

The Mini-Ion Vacuum Gauge Module can be mechanically mounted anywhere in a system in any attitude. It should be mounted in a location with free air flow and ambient temperature less than 40 °C.

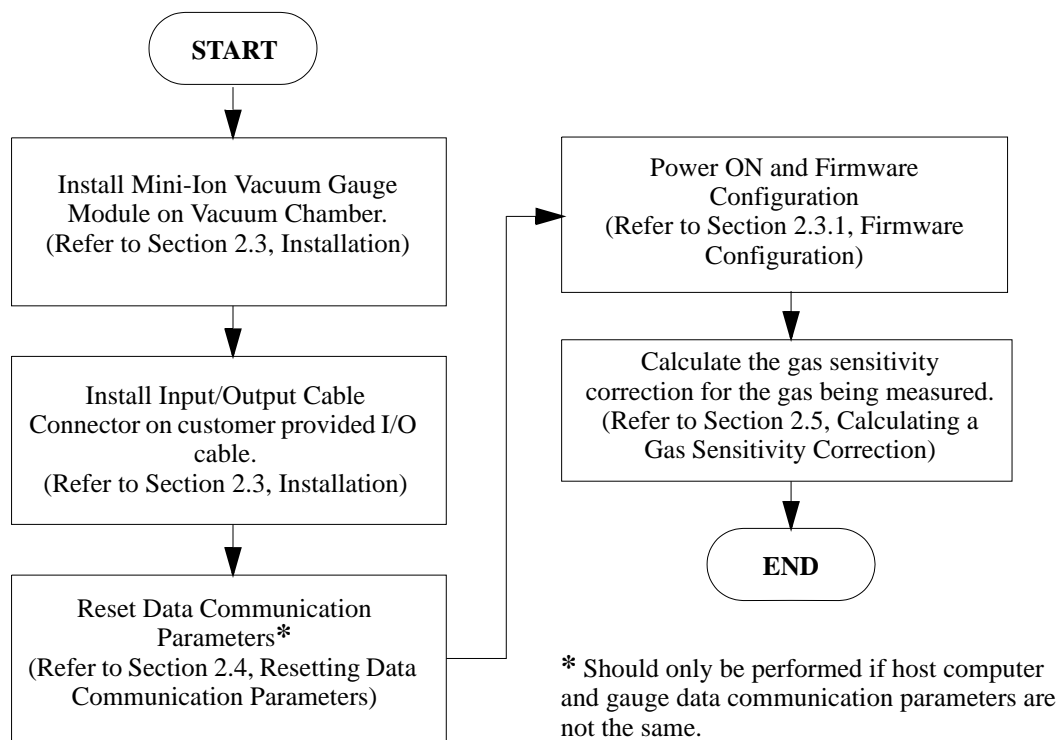

Figure 2-1 Mini-Ion Vacuum Gauge Module Installation (RS-485 Digital Interface)

2.1 Grounding

The Mini-Ion Vacuum Gauge Module converts the input power to +180 Vdc for the grid supply (+250 Vdc during degas). For safety, the outer housing of the gauge must be grounded to the vacuum chamber. This is accomplished by the use of a metal flange clamp for the NW type flanges. Due to the O-ring seal, grounding cannot be assumed through the fitting. The groove in the KF flange of the Mini-Ion Vacuum Gauge Module is designed to prevent the use of a non-metallic type of flange clamp. Do not alter the groove or a non-metallic flange clamp to attempt usage.

2.2 I/O Cable Connections

The I/O connector is used to operate the Mini-Ion Vacuum Gauge and provide connections for the setpoint relay. Refer to Table 2-1 for RS-485 connector pin assignments.

When no device is transmitting, the state of the RS-485 network will be indeterminate if no bias resistors exist because all RS-485 outputs will be tri-stated. To prevent potential problems with induced noise from external sources, bias resistors should be added somewhere on the RS-485 network. A 4.7K ohm resistor from the (-) RS-485 line to power ground and 4.7K ohm resistor from the (+) RS-485 line to a 5 Vdc source will force the network into a known state while outputs are tri-stated.

NOTE: The information in Section 2.2 applies only to a Mini-Ion Vacuum Gauge Module P/N 343033-EU with RS-485 digital interface.

2.3 Installation

Use the following procedure to install the Mini-Ion Vacuum Gauge Module (with RS-485 digital interface) on the vacuum system.



Reasonable care should be taken to install the Mini-Ion Vacuum Gauge Module where it is protected from physical damage.



Mini-Ion Vacuum Gauge Module grid supply voltages reach 180 Vdc during degas cycles. Use a metal flange clamp for NW type flanges to ensure the exterior module housing is grounded to the vacuum chamber.

NOTE: If an NW type flange is being used, ground the Mini-Ion Vacuum Gauge Module to the vacuum chamber by installing a metal flange clamp.

1. Connect the Mini-Ion Vacuum Gauge Module to the vacuum system flange using the appropriate gasket and mounting hardware.
2. Install the supplied connector on the customer supplied Input/Output cable according to the pin assignments in Table 2-1.

Table 2-1 RS-485 Digital Interface I/O Connector Pin Assignments

Pin	Function
1	No connection
2	No connection
3	Setpoint relay - N. C.
4	Setpoint relay - N. O.
5	Setpoint relay - common
6	Input power 24 Vdc \pm 15%, 12 W max.
7	Power ground
8	RS-485 (-)
9	RS-485 (+)

3. Connect the Input/Output cable to the connector on the Mini-Ion Vacuum Gauge Module.
4. Proceed with Section 2.3.1, Firmware Configuration.

2.3.1 Firmware Configuration

Use the following procedure to configure the Mini-Ion Vacuum Gauge Module (with RS-485 digital interface) and obtain a vacuum chamber pressure reading.

1. Set the address switch on the Mini-Ion Vacuum Gauge Module to the correct position for the vacuum chamber on which it is installed.
2. Turn the Mini-Ion Vacuum Gauge Module power supply ON.
3. If required, change the host computer data communication parameters to the Mini-Ion Vacuum Gauge Module *default* settings as shown in Table 1-3.

NOTE: The Mini-Ion Vacuum Gauge Module communication parameters can be changed later to match those of the host computer. Refer to Section 2.4 for more information.

4. Allow the vacuum chamber to acclimate to the correct vacuum pressure.

NOTE: Refer to Chapter 3, RS-485 Digital Interface Specifications and Protocol for additional information on the commands entered in Steps 5. through 8.

*NOTE: The address switch is set to the **01** position for demonstration purposes.*

5. Enter the **SE** command at the host computer for the desired emission current setting as follows:
 - a. Enter **#01SE2** — for 2.0 milliamperes emission current.
 - b. Enter **#01SE0** — for 0.1 milliamperes emission current.

The Mini-Ion Vacuum Gauge Module should respond with ***01_PROGM_OK**.

*NOTE: The values **1.00E-04** and **2.00E-04** in Step 6. are for demonstration purposes only. Substitute the appropriate values for your relay setpoints.*

6. Enter the appropriate **SL** command at the host computer to establish the setpoint at which the setpoint relay will turn ON or OFF as follows:
 - a. Enter **#01SL+1.00E-04** — to turn the setpoint relay ON when the pressure is less than $1.00E^{-04}$ Torr.
 - b. Enter **#01SL-2.00E-04** — to turn the setpoint relay OFF when the pressure is more than $2.00E^{-04}$ Torr.

The Mini-Ion Vacuum Gauge Module should respond with ***01_PROGM_OK**.

7. Enter the **IG** command at the host computer to turn the Mini-Ion Vacuum Gauge Module ON as follows:
 - a. Enter **#01IG1** to turn the gauge ON.
 - b. Enter **#01IG0** to turn the gauge OFF.

The Mini-Ion Vacuum Gauge Module should respond with ***01_PROGM_OK**.

8. Enter the **RD** command at the host computer to read the Mini-Ion Vacuum Gauge Module pressure response as follows:
 - a. Enter **#01RD** — the response will be **9.99E+09** for 5 seconds after executing **#01IG1** command, then a valid pressure response will be sent.



Overpressure shutdown parameters should not be changed from the default value. If set too low, the Mini-Ion Vacuum Gauge Module might turn OFF below chamber operating pressure. If set too high, inaccurate readings or Mini-Ion Vacuum Gauge Module damage may occur.

2.4 Resetting Data Communication Parameters

NOTE: This procedure should only be performed if the default Mini-Ion Vacuum Gauge Module communication parameters are the same as the host computer.

Use the following procedure to change the data communication parameters of the Mini-Ion Vacuum Gauge Module to match the host computer.

NOTE: Only perform Step 1. or 2. or 3. based upon the data format and parity of the host computer.

1. Enter the **SB** command at the host computer to change the baud rate as follows:
 - a. Enter **#01SBXXXX** — where **XXXX** equals one of the following baud rates: 300,600, 1200, 2400, 4800, 9600, 14400, 19200, or 28000.

The Mini-Ion Vacuum Gauge Module should respond with ***01_PROGM_OK**.

2. For a data format of *eight* (8) bits and parity of *none*, enter the **SPN** command at the host computer as follows:
 - a. Enter **#01SPN**

The Mini-Ion Vacuum Gauge Module should respond with ***01_PROGM_OK**.

3. For a data format of seven (7) bits and odd parity, enter the **SPO** command at the host computer as follows:

- a. Enter **#01SPO**

The Mini-Ion Vacuum Gauge Module should respond with ***01_PROGM_OK**.

4. For a data format of seven (7) bits and even parity, enter the **SPE** command at the host computer as follows:

- a. Enter **#01SPE**

The Mini-Ion Vacuum Gauge Module should respond with ***01_PROGM_OK**.

NOTE: The Mini-Ion Vacuum Gauge Module must be reset or the power must be cycled ON/OFF to begin using the new data communication values.

5. To reset the Mini-Ion Vacuum Gauge Module, enter the **RST** command at the host computer as follows:

- a. Enter **#01RST**

The Mini-Ion Vacuum Gauge Module will be reset and there will be no response.

6. Proceed with Section 2.5, Calculating a Gas Sensitivity Correction.

2.5 Calculating a Gas Sensitivity Correction

1. If measuring a gas other than nitrogen or air, refer to Table 2-2 and the following example to calculate the gas sensitivity correction for the gas being used.

Table 2-2 Ion Gauge Sensitivity Ratios.

Gas	Ratio
N ₂	1.00
H _e	0.18
N _e	0.30
A _r	1.29
K _r	1.94
X _e	2.87
H ₂	0.46

The Mini-Ion Vacuum Gauge Module indicates a pressure of 5×10^{-5} Torr. If the gas type is known to be neon, then perform the following calculation:

$$\frac{5 \times 10^{-5} \text{ Torr}}{0.30} = 1.67 \times 10^{-4} \text{ Torr of Neon}$$

2. Enter the calculated gas sensitivity correction into the host computer.

2.6 Very-High and Ultra-High Vacuum Measurement

When measuring vacuum pressures below 1×10^{-7} Torr:

- Use only all-metal vacuum fittings.
- Degas the Mini-Ion Vacuum Gauge Module grid. Refer to Section 4.6, Degas Cycle for more information.
- A process chamber bake to 100 to 150 °C is often required. Refer to Section 2.6.1 for more information.

2.6.1 Mini-Ion Vacuum Gauge Module for Process Chamber Baking

NOTE: The Mini-Ion Vacuum Gauge Module tube can be removed from the module without interrupting the vacuum within the process chamber.



The temperature of the Mini-Ion Vacuum Gauge Module cannot exceed 70 °C. The module electronics must be removed from the gauge tube before baking the chamber at temperatures higher than 70 °C.



To prevent electrical shock, shut down electrical power before servicing the Mini-Ion Vacuum Gauge Module. Do not touch any gauge pins while the gauge tube is under vacuum or connected to a controller.

1. Turn Mini-Ion Vacuum Gauge Module power OFF.
2. Remove the Input/Output connector from the module.
3. Remove the four Phillips head screws from the gauge collar plate as shown in Figure 2-2.
4. While holding the flange, *gently* pull the Mini-Ion Vacuum Gauge Module away from the gauge collar plate as shown in Figure 2-2. The gauge tube and plate will disconnect from the module.

NOTE: When baking the process chamber, make sure the temperature of the Mini-Ion Vacuum Gauge Module tube and the associated vacuum plumbing is raised to the same temperature as the process chamber. DO NOT EXCEED 200 °C.

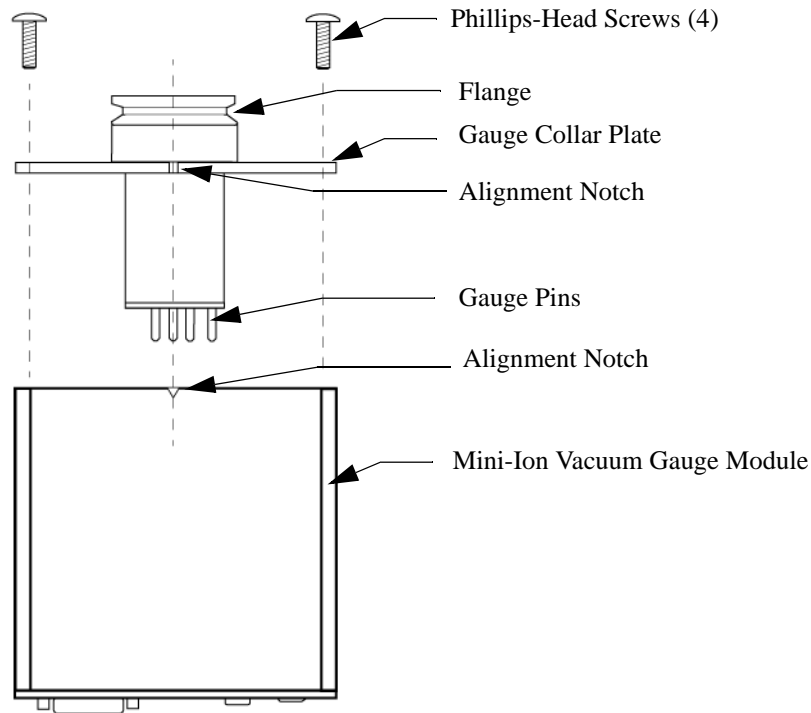

Figure 2-2 Module Removal for Baking Process Chamber.

5. Bake the process chamber at the desired temperature for the specified period of time (200 °C max.). Once the chamber has cooled to below 70° C, perform Steps 6. through 11.
6. Align the notches on the gauge collar plate and the Mini-Ion Vacuum Gauge Module as shown in Figure 2-2.
7. *Gently* insert the gauge and collar plate into the Mini-Ion Vacuum Gauge Module until the tube pins are inserted into the tube socket.
8. Insert and tighten all four Phillips head screws.
9. Install the Mini-Ion Vacuum Gauge Module to the vacuum system.
10. Connect the Input/Output connector to the Mini-Ion Vacuum Gauge Module.
11. Turn ON power to the Mini-Ion Vacuum Gauge Module and verify communication.

Notes:

RS-485 Digital Interface Specifications and Protocol

This chapter provides the syntax and description of the commands used in the Mini-Ion Vacuum Gauge Module with RS-485 digital interface P/N 343033-EU.

3.1 Interface Configuration

Default - 19.2 KB 8 bits

1 stop bit, no parity

Address = 01

3.2 Command Syntax

Command from host must include a start character, address, data and terminator.

(Start character)(address)(data)(terminator)

- The start character is #.
- The address is two ASCII digits representing the Hex address of the module. This address will also be displayed on the front panel in a hex format. For example: 0F Hex is address 15 Decimal.
- The data field is explained in the command descriptions. All alpha characters can be upper or lower case.
- The terminator character is control M or Hex 0D for a carriage return, signified by CR.

A space character is signified by _.

All data fields responses will contain 13 characters, upper case alpha characters.

A response of **?01_SYNTAX_ER CR** is caused by an incorrect character string from the host.

NOTE: The speed of the response from the Mini-Ion Vacuum Gauge Module varies depending on the type of command being carried out. Refer to Section 3.3, Receive/Transmit Timing.

3.2.1 Command Descriptions

RD

Definition: Read Mini-Ion Vacuum Gauge Module pressure response.

Example: From computer: #01RD CR

From Mini-Ion Vacuum Gauge Module: *01_9.34E-06 CR

NOTES:

The response will be **9.99E+09** for 5 seconds after the gauge is turned ON then valid pressures will be sent. A response of **9.99E+09** will be sent if the ion gauge is OFF.

IG

Definition: Control Mini-Ion Vacuum Gauge Module status.

Example: From computer: #01IG1 CR

From Mini-Ion Vacuum Gauge Module: *01_PROGM_OK CR

NOTES:

IG1 = turn ON Mini-Ion Vacuum Gauge Module.

IG0 = turn OFF Mini-Ion Vacuum Gauge Module.

Initial **RD** reading will be **9.99E+09** for 5 seconds, then valid pressure readings will be received if emission status is **OK**.

DG

Definition: Control degas (10 mA) status.

Example: From computer: #01DG1 CR

From Mini-Ion Vacuum Gauge Module: *01_PROGM_OK CR

NOTES:

DG1 = turn ON degas.

DG0 = turn OFF degas.

Another possible response is **?01_COM_ERR CR**. This response occurs if the Mini-Ion Vacuum Gauge Module is OFF. The Mini-Ion Vacuum Gauge Module must be ON before starting degas. Degas will run for a maximum of 2 minutes then turn OFF automatically.

SE

Definition: Control emission status.

Example: From computer: #01SE2 CR

From Mini-Ion Vacuum Gauge Module: *01_PROGM_OK CR

NOTES:

SE2 = 2 mA emission.

SE0 = 0.1 mA emission.

2 mA emission is used to get accurate readings at pressures below 1e-6 Torr, 0.1 mA emission is used to get extended gauge life above 2e-4 Torr. This programming is non-volatile, the setting selected will remain in effect even if power is cycled.

SO

Definition: Set over pressure setpoint.

Example: From computer: #01SO5.00E-03 CR

From Mini-Ion Vacuum Gauge Module: #01_PROGM_OK CR

NOTES:

The Mini-Ion Vacuum Gauge Module will turn OFF if the pressure is greater than this value. The factory setting for a Mini-Ion Vacuum Gauge Module is 5.00E-3 Torr. This programming is non-volatile. The setting selected will remain in effect even if power is cycled.

Another possible response is ?01_SYNTAX_ERR. This is caused by the use of the wrong notation in the command data field.



To obtain optimum filament life, Mini-Ion Vacuum Gauge Modules equipped with tungsten filaments should not be operated above 5×10^{-3} Torr in air.

SA

Definition: Set offset address

Example: From computer: #01SA20 CR

From Mini-Ion Vacuum Gauge Module: *01_PROGM_OK CR

NOTES:

The address switch setting is added to this Hex value.

Example: Address switch is set at 2 and offset value is 20 Hex, then the module address is 22 Hex. The operating address will not change until the power is cycled or RST is sent.

SL

Definition: Set setpoint 1 trip point.

Examples: From computer: #01SL+1.00E-04 CR

From Mini-Ion Vacuum Gauge Module: *01_PROGM_OK CR

From computer: #01SL-2.00E-04 CR

From Mini-Ion Vacuum Gauge Module: *01_PROGM_OK CR

NOTES:

The above example will turn ON or energize the relay when the pressure is less than 1.00E-04 TORR, for nitrogen. The relay will turn OFF when the pressure goes above 2.00E-04 TORR. The '-' value from the computer sets the relay OFF point and the '+' value set the relay ON point. The above example turns on the relay below the setpoint. To turn ON the relay above the setpoint, the '-' value must be lower than the '+' value. **SL+** **SL-** may be set for the same pressure. If this is done, the second **SL_** command will determine the relay logic. **SL+** sent last will generate a *01_+MIN_HYS response and the relay will energize BELOW the setpoint. **SL-** sent last will generate a *01_-MIN_HYS response and the relay will energize ABOVE the setpoint.

RL

Definition: Read setpoint 1 trip point.

Example: From computer: #01RL-CR

From Mini-Ion Vacuum Gauge Module: *01-9.80E-02 CR

NOTES:

RL+ reads setpoint ON value. The value begins with a plus sign.

RL- reads setpoint OFF value. The value begins with a minus sign.

IGS

Definition: Read Mini-Ion Vacuum Gauge Module Status.

Examples: From computer: #01IGS CR

From Mini-Ion Vacuum Gauge Module: *01_0_IG_OFF CR

From computer: #01IGS CR

From Mini-Ion Vacuum Gauge Module: *01_1_IG_ON_ CR

DGS

Definition: Read Mini-Ion Vacuum Gauge Module Degas Status.

Examples: From computer: #01DGS CR

From Mini-Ion Vacuum Gauge Module: *01_0_DG_OFF CR

From computer: #01DGS CR

From Mini-Ion Vacuum Gauge Module: *01_1_DG_ON_CR

SES

Definition: Read Emission Status.

Examples: From computer: #01SES CR

From Mini-Ion Vacuum Gauge Module: *01_0.1MA_EM CR

From computer: #01SES CR

From Mini-Ion Vacuum Gauge Module: *01_2.0MA_EM CR

RS

Definition: Read Controller Status.

Example: From computer: #01RS CR

From Mini-Ion Vacuum Gauge Module: *01_00_ST_OK CR

NOTES:

The response is dependent on the cause of gauge shutdown.

00_ST_OK indicates normal user control.

01_OVPRS indicates overpressure condition caused gauge shutdown. See **SO** command to control overpressure setpoint.

02_EMISS indicates emission control failure. Causes include gauge failure due to broken filament or contamination or pressure over 1 Torr.

04_HIVLT indicates high voltage power to gauge failed. Causes include gauge failure due to mechanical damage or electrical leakage current due to contamination.

08_POWER indicates power to controller was interrupted.

The number value for each status indication represents a bit weight in the hexadecimal representation of this binary number. It is possible to have multiple bits set and cause a response like **06_EMISS**. This indicates a **HIVOLT** and a **EMISS** failure. The status will remain the

same with repeated queries from the computer until the Mini-Ion Vacuum Gauge Module is turned ON. Turning ON the Mini-Ion Vacuum Gauge Module will cause the status to be reset to **00**.

VER

Definition: Read Mini-Ion Vacuum Gauge Module firmware version.

Example: From computer: #01VER CR

From Mini-Ion Vacuum Gauge Module: *01_13016-00 CR

NOTE:

In this example, **13016** is the internal part number, **00** is the revision. Larger revision numbers indicate newer versions of firmware.

FAC

Definition: Set factory default

Example: From computer: #01FAC CR

From Mini-Ion Vacuum Gauge Module: *01_PROGM_OK CR

NOTES:

This can be used when a Mini-Ion Vacuum Gauge Module is not responding properly.

Cycle power or send **RST** after doing this function.

FAC will cause default communication and transducer parameters to be programmed:

Base Address = 00

Baud rate = 19200, data format = 8 bits, no parity, 1 stop bit

RS-485 operation

SB

Definition: Set baud rate

Example: From computer: #01SB2400 CR

From Mini-Ion Vacuum Gauge Module: *01_PROGM_OK CR

NOTES:

Will continue to operate at old baud rate until power is cycled or **RST** command is sent.

Max. baud rate is 28000. Allowable baud rates are: 28000, 19200, 14400, 9600, 4800, 2400, 1200, 600, 300.

SPN

Definition: Set parity to 8 bits, none

Example: From computer: #01SPN CR

From Mini-Ion Vacuum Gauge Module: *01_PROGM_OK CR

NOTE:

Will continue to operate at old format until power is cycled or **RST** command is sent.

SPO

Definition: Set parity to 7 bits, odd

Example: From computer: #01SPO CR

From Mini-Ion Vacuum Gauge Module: *01_PROGM_OK CR

NOTE:

Will continue to operate at old format until power is cycled or **RST** command is sent.

SPE

Definition: Set parity to 7 bits, even

Example: From computer: #01SPE CR

From Mini-Ion Vacuum Gauge Module: *01_PROGM_OK CR

NOTE:

Same as **SPN**.

RST

Definition: Reset module

Example: From computer: #01RST CR

NOTE:

The **RST** command will reset the module as if the power had been cycled. **RST** has no response. Communication is re-enabled in 2 seconds.

UNL

Definition: Unlock Interface Speed and Framing Programming

Example: From computer: #01UNL CR

From Mini-Ion: 01_PROGM_OK_CR

NOTES:

If the **UNL** command is enabled by the **TLU** command, the **UNL** command must be executed in sequence prior to any of these commands: **SB**, **SPN**, **SPO** and **SPE** when enabled.

If any of these commands are attempted without the **UNL** command, a response of **?01_COM-ERR CR** will be generated.

If **UNL** is not enabled by **TLU** command, response to **UNL** will be **?01_SYNTAX_ER**.

TLU

Definition: Toggle UNL Function

Example: From computer: #01TLU CR

From Mini-Ion: *01_1_UL_ON_CR

From computer: #01TLU CR

From Mini-Ion: *01_1_UL_OFF_CR

NOTES:

The **TLU** command will *toggle* the state of the **UNL** function.

When response is **UL_ON**, then **UNL** is required to execute **SPN**, **SPO**, **SPE**, or **SB** functions.

When response is **UL_OFF**, then **UNL** is not required and any attempt to execute **UNL** will generate a **?01_SYNTAX_ER**.

TLU programming is non-volatile, the setting selected will remain in effect even if power is cycled.

3.3 Receive/Transmit Timing

The speed of the response from the Mini-Ion Vacuum Gauge Module varies depending on the type of command being carried out. All commands will cause a response to begin in less than 100 msec.

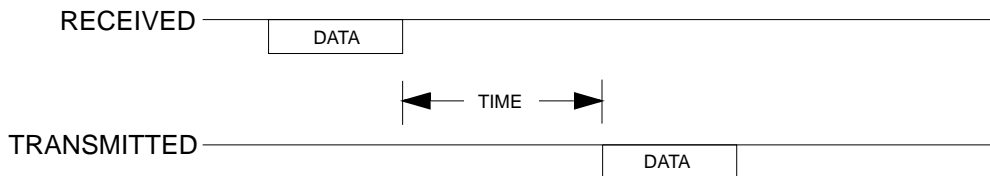

Figure 3-1 Receive/Transmit Timing

NOTE: The Mini-Ion Vacuum Gauge Module will shut off its driver 80 μ sec after sending data to the host.

Depending on the selected baud rate, there will be an additional delay for the 13 character response from the Mini-Ion Vacuum Gauge Module, as noted in Table 3-1.

Table 3-1 Baud Rate and Receive, Transmit Time of Response

Baud Rate	RX and TX Added Response Time
28,800	3.3 msec
19,200	3.9 msec
9,600	5.1 msec
4,800	7.5 msec
2,400	13.0 msec
1,200	22.0 msec
300	79.0 msec

Depending on the command sent, there will be the additional delays noted in Table 3-2.

Table 3-2 Additional Response Time

Command	Time Added
FAC	105 msec
RD	0 msec
RST	No Response
All other commands	17 msec

Notes:

Service and Maintenance

4.1 Service Guidelines

The procedures in this section provide instructions for normal service issues that may be required during use of the Mini-Ion Vacuum Gauge Module.

Because the Mini-Ion Vacuum Gauge Module contains static-sensitive electronic parts, the following precautions must be followed when troubleshooting:

- Use a grounded, conductive work surface. Wear a high impedance ground strap for personnel protection.
- Use conductive or static dissipative envelopes to store or ship static sensitive devices or printed circuit boards.
- Do not operate the product with static sensitive devices or other components removed from the product.
- Do not handle static sensitive devices more than absolutely necessary, and only when wearing a ground strap.
- Use a grounded, electrostatic discharge safe soldering iron.

NOTE: This product was designed and tested to offer reasonably safe service provided it is installed, operated, and serviced in strict accordance with these safety instructions.



The service and repair information in this manual is for the use of Qualified Service Personnel. To avoid electrical shock, do not perform any procedures in this manual or perform any servicing on this product unless you are qualified to do so.



Do not substitute parts or modify instrument.

Because of the danger of introducing additional hazards, do not install substitute parts or perform any unauthorized modification to the product. Return the product to a service facility designated by Granville–Phillips for service and repair to ensure that safety features are maintained. Do not use this product if it has unauthorized modifications.

4.2 Damage Requiring Service

Disconnect this product from all power sources, and refer servicing to Qualified Service Personnel if any the following conditions exist:

- The gauge cable, power-supply cord, or plug is damaged.
- Liquid has been spilled onto, or objects have fallen into, the product.
- The product has been exposed to rain or water.
- The product does not operate normally even if you have followed the Operation Instructions. Adjust only those controls that are covered in the instruction manual. Improper adjustment of other controls may result in damage and require extensive work by a qualified technician to restore the product to its normal operation.
- The product has been dropped or the enclosure has been damaged.

- The product exhibits a distinct change in performance. This may indicate a need for service.

 **Replacement Parts** – When replacement parts are required, be certain to use the replacement parts that are specified by Granville–Phillips, or that have the same characteristics as the original parts. Unauthorized substitutions may result in fire, electric shock or other hazards.

 **Safety Check** – Upon completion of any service or repairs to this product, ask the Qualified Service Person to perform safety checks to determine that the product is in safe operating order.

 **Finite Lifetime** – After ten years of normal use or even non–use, the electrical insulation in this product may become less effective at preventing electrical shock. Under certain environmental conditions which are beyond the manufacturer’s control, some insulation material may deteriorate sooner. Therefore, periodically inspect all electrical insulation for cracks, crazing, or other signs of deterioration. Do not use if the electrical insulation has become unsafe.

4.3 Troubleshooting

The problems presented in Table 4-1 are followed by possible causes and corrective actions.

 **High voltage is present inside the Mini–Ion Vacuum Gauge Module.**

Table 4-1 General Symptoms/Possible Causes

Symptom	Possible Causes
Unit does not respond to RS-485 communication from a host, but the Power Indicator lights.	<p>The I/O connector may be wired incorrectly. Reverse the RS485 (+) and (-) connections.</p> <p>No bias resistors. Bias resistors are missing. Refer to Section 2.2, I/O Cable Connections.</p> <p>Address rotary switch set to incorrect address position. Set the switch in the correct address position.</p> <p>Incorrect baud rate or data format programmed. Refer to Section 4.5, Mini-Ion Vacuum Gauge (with Digital Interface) Module Initialization.</p>
Power indicator does not light.	<p>Power supply disconnected, off, or inadequate for load. A switching supply may shut down from the current surge upon power up. If a switching power supply is used, size current limit to two times working load. Refer to Table 1-1.</p> <p>The I/O connector may be wired incorrectly. Refer to Section 2.2, I/O Cable Connections.</p> <p>Blown fuse. This could be caused by wrong wiring or low power supply voltage. Replace the fuse with a 1 ampere, slow blow Littlefuse 229001, G-P P/N 012084. Refer to Section 4.7, Fuse Replacement.</p>
Mini-Ion Vacuum Gauge Module will not stay on (always reads 9.99e+09, response to IGS always 0).	<p>Fault condition indicated by reading response to RS. Refer to the RS command.</p>

Symptom	Possible Causes
Inaccurate pressure reading.	<p>Organic seals. If the Mini-Ion Vacuum Gauge Module connection to the vacuum system is sealed with an organic O-ring the gauge will not read accurately below 1e-7 Torr. Replace O-ring with a metal seal.</p> <p>Mechanical damage. If the unit is dropped or excessive force is applied to the vacuum connection during installation, gauge elements may be damaged or pin leaks may occur. Refer to Section 4.4, Mini-Ion Vacuum Gauge Module Ion Gauge Continuity Test.</p> <p>Contamination. Pump oil and other organic compounds or metal coating from a sputtering process can cause electrical current leakage between Mini-Ion Vacuum Gauge Module elements. Degas the Mini-Ion Vacuum Gauge Module by executing the DG command. Several degas cycles may be required to clean up the Mini-Ion Vacuum Gauge Module. If this does not work, the gauge may be heated externally with the electronics module removed.</p>
Process control setpoint does not function as expected.	<p>The I/O connector may be wired incorrectly. Refer to Section 2.2, I/O Cable Connections.</p> <p>Wrong setpoint values programmed. Read SL+ and SL- data. If returned values are wrong, program SL+ and SL- with proper values. Refer to the SL command.</p> <p>NOTE: The process control setpoint will always have the COMMON contact connected to the N.C. contact when the Mini-Ion Vacuum Gauge Module is OFF or when the unit is not powered.</p>

4.4 Mini-Ion Vacuum Gauge Module Ion Gauge Continuity Test



To prevent electrical shock, turn OFF electrical power before servicing the Mini-Ion Vacuum Gauge Module. Do not touch any gauge pins while the gauge tube is under vacuum or connected to a controller.

This test should only be performed while the ion gauge is exposed to atmospheric pressure and the Mini-Ion Vacuum Gauge Module electronics is removed from the gauge. If a problem with pressure measurement is traced to the Mini-Ion Vacuum Gauge Module, the gauge may be tested with an ohm meter. This test can detect open filaments or shorts between gauge elements. This test may not detect inaccurate pressure measurement due to gauge contamination or vacuum leaks.

1. Turn OFF power to the module.
2. Remove the I/O connector from the module.
3. Remove the Mini-Ion Vacuum Gauge Module from the vacuum system.
4. Remove the four Phillips head screws from the gauge collar plate as shown in Figure 4-1.

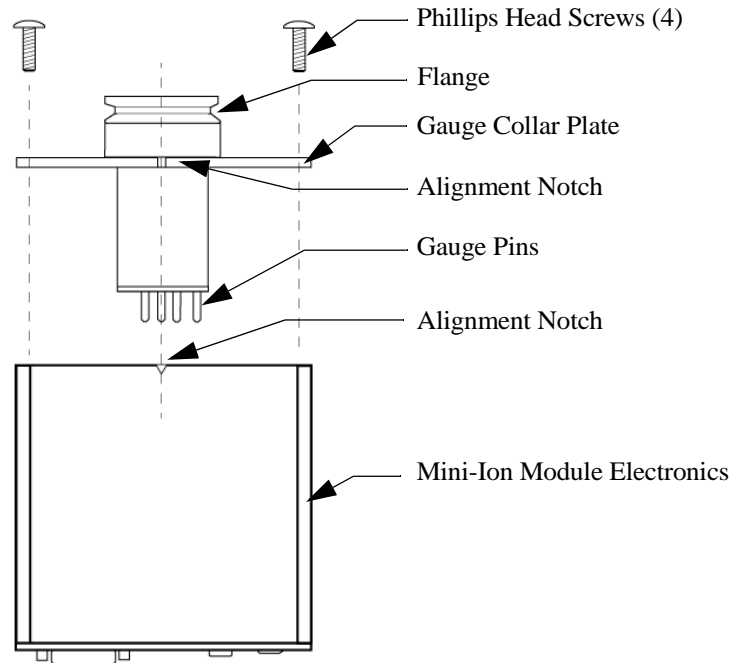

Figure 4-1 Mini-Ion Vacuum Gauge Module Removal

5. While holding the flange, *gently* pull the Module away from the gauge collar plate as shown in Figure 4-1. The gauge tube and plate will disconnect from the module.
6. Using a digital multimeter, measure the resistance of the filament between filament pins as shown in Figure 4-2. The reading should be approximately 0.2 Ohm.

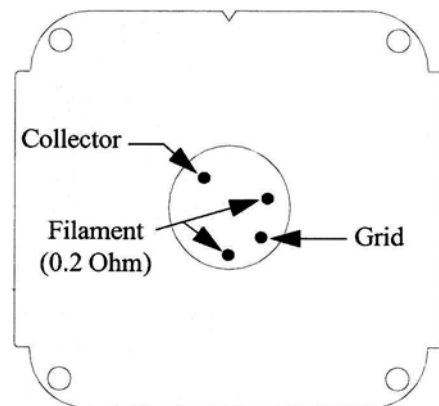

Figure 4-2 Mini-Ion Module Pin Identification

7. Measure the resistance of filament pins to any other pin or gauge case as shown in Figure 4-2. The reading should be infinity.
8. Measure the resistance of Grid pins to any other pin or gauge case as shown in Figure 4-2. The reading should be infinity.
9. Measure the resistance of Collector pin to any other pin or gauge case as shown in Figure 4-2. The reading should be infinity.

NOTE: If the readings obtained during this procedure are not within the values specified, the gauge should be replaced. Contact Granville-Phillips Customer Service to order a replacement gauge.

4.5 Mini-Ion Vacuum Gauge (with Digital Interface) Module Initialization

The Mini-Ion Module may have been set to incorrect communication parameters which may cause communication problems. When these problems occur, the communication parameters should be initialized to the factory set default values listed in Table 4-2.

Table 4-2 Mini-Ion Module Default Communication Parameters

Parameter	Default Value
Baud Rate	19,200
Data Format	8 bits
Parity	None
Stop Bits	1

4.5.1 Initialization

Use the following procedure to initialize the Mini-Ion Module.



To prevent electrical shock, turn OFF electrical power before servicing the Mini-Ion Module.

1. Turn OFF power to the module.
2. Disconnect the I/O cable from the connector.
3. Remove the I/O cable connector jack posts from the connector.
4. Remove the four screws from the Mini-Ion Module top cover and remove the cover.



Make sure the jumper is installed only on the pins shown in Figure 4-3. Otherwise, damage to the Mini-Ion Module may occur.

5. Connect a jumper wire to the pins as shown in Figure 4-3.

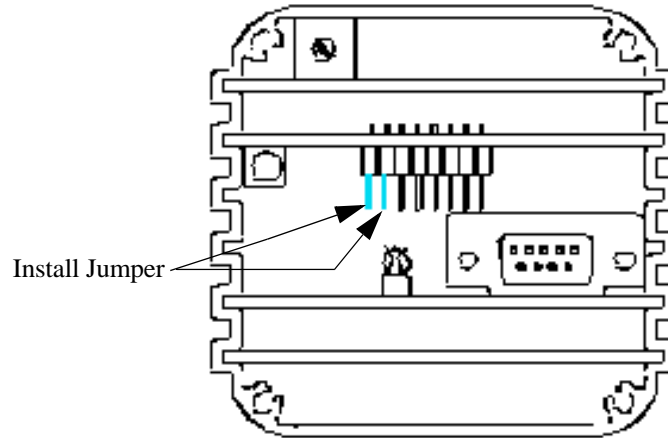

Figure 4-3 Jumper Installation Location (Cover Removed)

6. Reconnect the I/O cable.
7. Turn ON power to the Mini-Ion Module. The Module will initialize to the parameters in Table 4-2.
NOTE: The Module will not read pressure while the jumper is installed.
8. Make sure the address rotary switch on the Module is set to the correct address position.
9. From the host computer, send the following commands to the Module:
 - a. Enter the **#XX** command.
Where XX depends upon the switch position.
 - b. Enter the **FAC** command.

The Module should respond with ***0X_PROGM_OK** which indicates it is communicating properly with the host computer.

10. Turn OFF power to the Module.
11. Remove the jumper.
12. Disconnect the I/O cable from the connector.
13. Install the Module top cover with the previously removed four screws.
14. Install the I/O cable connector jack posts on the connector.
15. Connect the I/O cable to the connector.
16. Turn ON power to the Module. It is now ready to be used.

4.6 Degas Cycle

Pump oil, other organic compounds, or metal coatings from a sputtering process can cause electrical current leakage between the ion gauge tube elements. When contamination occurs, system base pressure readings may begin to rise which is an indication that a degas cycle will have to be performed.

Once initiated, the degas cycle will apply approximately 3 watts of power to the ion gauge for two minutes and turn OFF automatically.

NOTE: Depending upon the level of contamination, several degas cycles may be required to remove the contamination from the ion gauge tube.

Use the appropriate procedure to remove contamination from the ion gauge tube for the digital or analog interface Mini-Ion Vacuum Gauge Module.

4.6.1 Digital Interface

1. Turn ON the Mini-Ion Vacuum Gauge Module.
2. Enter the *DG* command at the host computer to start a degas cycle on the Mini-Ion Vacuum Gauge Module as follows:
 - a. Enter **#01DG1** to initiate a degas cycle.
 - b. Enter **#01DG0** to abort a degas cycle.

The Mini-Ion Vacuum Gauge Module should respond with ***01_PROGM_OK**.

3. Once the degas cycle is complete, check the system base pressure reading again. If the reading is still high, repeat this procedure until the system base pressure is within its normal range.

4.7 Fuse Replacement

Use the following procedure to replace the fuse in the Mini-Ion Vacuum Gauge Module.



To prevent electrical shock, turn OFF electrical power before servicing the Mini-Ion Vacuum Gauge Module.

1. Turn OFF power to the Mini-Ion Vacuum Gauge Module.
2. Disconnect the I/O cable from the connector.
3. Remove the I/O cable connector jack posts from the connector.
4. Remove the four screws from the Mini-Ion Vacuum Gauge Module top cover and remove the cover.
5. Locate the defective fuse as shown in Figure 4-4 and replace it with a new 1 amp, slow blow fuse.

1 Amp, Slow Blow Fuse
Littlefuse 229001, 2AG, 250V
Granville-Phillips P/N 012084

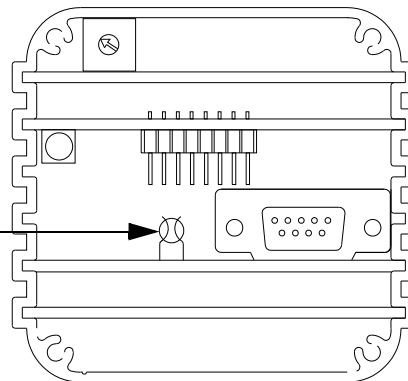

Figure 4-4 Position of 1 Amp, Slow Blow Fuse

6. Install the Mini-Ion Vacuum Gauge Module top cover with the previously removed four screws.

7. Install the I/O cable connector jack posts on the connector.
8. Connect the I/O cable to the connector.
9. Turn ON power to the Mini-Ion Vacuum Gauge Module. It is now ready to be used.

4.8 Mini-Ion Vacuum Gauge Module Replacement



To prevent electrical shock, shut down electrical power before servicing the Mini-Ion Vacuum Gauge Module. Do not touch any gauge pins while the gauge tube is under vacuum or connected to a controller.

1. Turn OFF power to the Mini-Ion Vacuum Gauge Module.
2. Remove the Input/Output connector from the module.
3. Remove the Mini-Ion Vacuum Gauge Module from the vacuum system.
4. Remove the four Phillips-head screws from the gauge collar plate as shown in Figure 4-5.
5. While holding the flange, gently pull the Mini-Ion Vacuum Gauge Module away from the gauge collar plate as shown in Figure 4-5. The gauge tube and plate will disconnect from the module.
6. Align the notches on the replacement gauge collar plate and the Mini-Ion Vacuum Gauge Module as shown in Figure 4-5.
7. Gently insert the replacement gauge and collar plate into the Mini-Ion Vacuum Gauge Module until the tube pins are inserted into the tube socket.
8. Insert and tighten all four Phillips-head screws.
9. Install the Mini-Ion Vacuum Gauge Module to the vacuum system.
10. Connect the Input/Output connector to the Mini-Ion Vacuum Gauge Module.
11. Turn ON power and verify communication to the Mini-Ion Vacuum Gauge Module.

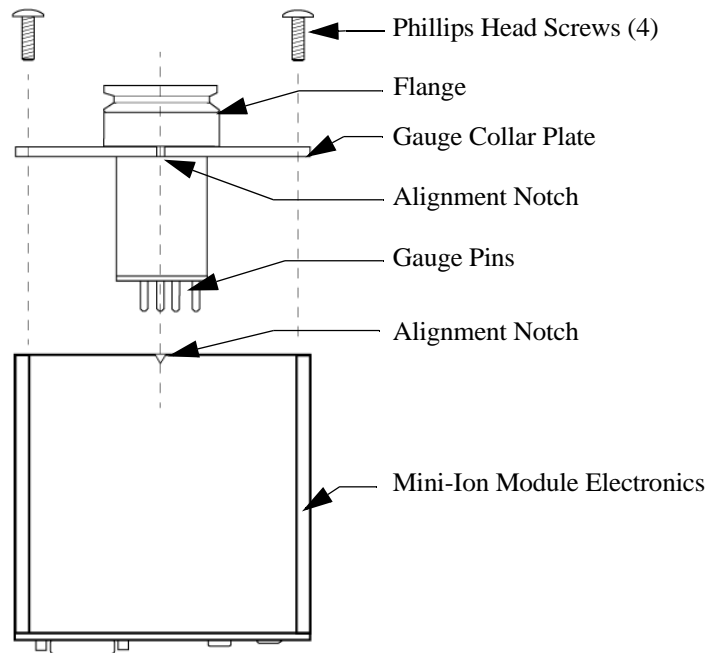

Figure 4-5 Mini-Ion Vacuum Gauge Module Replacement

4.9 Customer Service / Technical Support

Some minor problems are readily corrected on site. If the product requires service, contact the MKS/Granville-Phillips Technical Support Department at 1-303-652-4400 for troubleshooting help over the phone.

If the product must be returned to the factory for service, request a Return Material Authorization (RMA) from Granville-Phillips. Do not return products without first obtaining an RMA. In some cases a hazardous materials disclosure form may be required. The MKS/Granville-Phillips Customer Service Representative will advise you if the hazardous materials document is required.

When returning products to Granville-Phillips, be sure to package the products to prevent shipping damage. Shipping damage on returned products as a result of inadequate packaging is the Buyer's responsibility.

For Customer Service / Technical Support:

MKS Pressure and Vacuum Measurement Solutions

MKS Instruments, Inc., Granville-Phillips® Division
6450 Dry Creek Parkway
Longmont, Colorado 80503 USA
Tel: 303-652-4400
Fax: 303-652-2844
Email: mks@mksinst.com

MKS Corporate Headquarters

MKS Instruments, Inc.
2 Tech Drive, Suite 201
Andover, MA 01810 USA
Tel: 978-645-5500
Fax: 978-557-5100
Email: mks@mksinst.com

Series 343

Granville-Phillips® Mini-Ion™ Vacuum Gauge Module with RS-485 Digital Interface



Customer Service / Technical Support:

MKS Pressure and Vacuum Measurement Solutions

MKS Instruments, Inc., Granville-Phillips® Division

6450 Dry Creek Parkway

Longmont, Colorado 80503 USA

Tel: 303-652-4400

Fax: 303-652-2844

Email: mks@mksinst.com

MKS Corporate Headquarters

MKS Instruments, Inc.

2 Tech Drive, Suite 201

Andover, MA 01810 USA

Tel: 978-645-5500

Fax: 978-557-5100

Email: mks@mksinst.com

Instruction Manual

Instruction manual part number 343048

Revision B - November 2016