

**MKS Type 1153A  
Low Vapor Pressure Source  
Mass Flow Controller**

*Copyright © 1997 by MKS Instruments, Inc.*

*All rights reserved. No part of this work may be reproduced or transmitted in any form or by any means, electronic or mechanical, including photocopying and recording, or by any information storage or retrieval system, except as may be expressly permitted in writing by MKS Instruments, Inc.*

Baratron® is a registered trademark of MKS Instruments, Inc., Andover, MA

Cajon®, VCR®, and VCO® are registered trademarks of Cajon Company, Macedonia, OH

Kalrez® and Viton® are registered trademarks of E. I. DuPont de Nemours and Co. Inc.,  
Wilmington, DE

Swagelok® is a registered trademark of Crawford Fitting Company, Solon, OH

NUPRO® is a registered trademark of NUPRO Company, Willoughby, OH

Inconel® is a registered trademark of Inco Alloys International, Huntington, WV

---

## Table of Contents

Safety Information .....	1
Symbols Used in This Instruction Manual.....	1
Symbols Found on the Unit.....	2
Safety Procedures and Precautions .....	3
Chapter One: General Information.....	5
Introduction.....	5
How This Manual is Organized .....	6
Customer Support .....	7
Chapter Two: Installation.....	9
How To Unpack the Type 1153 Unit.....	9
Unpacking Checklist .....	9
Product Location and Requirements .....	10
Setup.....	11
Dimensions.....	11
Power Requirements .....	13
Operating Temperature .....	13
Gas Source .....	13
Mounting Instructions .....	16
Connectors .....	18
RS-232 Serial Interface Connector .....	19
Interface Connector.....	20
DC Power Connector .....	21
AC Power Connector .....	22
Start Up .....	23
Default Operating Mode .....	24
Warm Up Time .....	24
Status LED .....	25
Chapter Three: Overview .....	27
Functional Description.....	27

Mass Flow Measurement Theory.....	27
Proportional - Integral (PI) Control Theory.....	29
Valve Orifice Size.....	32
Flow Control Range.....	32
Calibration.....	33
Calibration Data Sheet.....	34
Calibration Parameters.....	35
Labels.....	38
Warning Label.....	38
Serial Number Label.....	38
Chapter Four: Analog Operation.....	39
General Information.....	39
How To Set the Temperature Set Point.....	39
How To Set the Flow Set Point.....	40
How To Control the Operation of the Valve.....	40
How To Open the Valve.....	40
How To Close the Valve.....	40
How To Set the Valve to Control to the Flow Set Point.....	40
Chapter Five: RS-232 Operation.....	41
General Information.....	41
RS-232 Communication Parameters.....	42
RS-232 Protocol.....	43
Message Syntax.....	43
Commands and Requests.....	44
Responses.....	47
Required Data Format.....	49
Setup Messages.....	50
How To Change the Baud Rate.....	52
How To Set the Comm State Flag.....	52
How To Set the Full Scale Flow Range.....	53
How To Set the Full Scale Temperature Range.....	53
How To Set the Maximum Temperature.....	54

---

How To Set the “K” Constant Value .....	55
How To Set the Valve Control Parameters .....	56
How To Set the Valve Conductance Levels .....	57
How To Set the Valve Current Levels .....	58
How To Set the Molecular Weight .....	59
How To Set the Full Range of the Calibration Constant Table .....	60
How To Setup the Calibration Constant Table .....	61
How To Save Data to the EEPROM .....	62
How To Reset the Factory Settings .....	62
Control Messages .....	63
How To Set the Flow Set Point .....	64
How To Set the Temperature Set Point .....	65
How To Turn the Temperature Controller OFF .....	66
How To Turn the Temperature Controller ON .....	66
How To Control the Operation of the Valve .....	67
Informational Messages .....	68
How To Report the System Status .....	70
How To Clear the Reset Bit .....	71
How To Report the Software Version .....	71
How To Report the Gas Flow .....	72
How To Report the Temperature .....	72
How To Report the Pressure .....	73
How To Report the Type of Valve Operation .....	74
How To Report the Power Required by the Heaters .....	74
How To Report the Discharge Coefficient .....	75
How To Report the System Reference Voltage .....	75
Chapter Six: Maintenance and Troubleshooting .....	77
General Information .....	77
Maintenance .....	77
System Checks .....	78
How To Adjust the Transducer Zero .....	79
Troubleshooting .....	80
Electrostatic Discharge .....	80

Troubleshooting Chart .....	80
Appendix A: Product Specifications .....	83
Appendix B: Model Code Explanation .....	85
Product Type .....	85
Configuration .....	85
Appendix C: Application Specific Parameters .....	87
RS-232 Application Specific Messages .....	87
How To Change the Address .....	88
How To Set the Baratron Full Scale Ranges .....	89
How To Set the Baratron Gain and Offset Parameters .....	90
How To Set the Nozzle Diameter .....	92
How To Set the Valve Current.....	92
How To Report the Temperature Control Parameters .....	93
How To Set the Overall Calibration Constant .....	94
Appendix D: RS-232 Command Summary .....	95
Appendix E: ASCII Value Chart.....	101
Index.....	103

---

## List of Figures

Figure 1: Front Panel Dimensions .....	11
Figure 2: Side Panel Dimensions .....	12
Figure 3: Baseplate Dimensions .....	12
Figure 4: Typical Source Feed Line Setup.....	14
Figure 5: Typical System Configuration.....	17
Figure 6: Rear Panel of the 1153 Unit .....	18
Figure 7: Flow Rate Versus Valve Current.....	30
Figure 8: Typical Effects of Downstream Pressure ( $P_2$ ) on the Control Range .....	32
Figure 9: Example Calibration Data Sheet .....	34
Figure 10: Example Calibration Parameter Data Sheet - User Gas .....	36
Figure 11: Example Calibration Parameter Data Sheet - Calibration Gas.....	37
Figure 12: Warning Label .....	38
Figure 13: Serial Number Label.....	38
Figure 14: Example Command Message .....	44
Figure 15: ASCII Characters in a Command Message Used to Calculate the Checksum .....	45
Figure 16: Example Response Message.....	47





---

## List of Tables

Table 1: Definition of Symbols Found on the Unit .....	2
Table 2: RS-232 Serial Interface Connector Pinout.....	19
Table 3: Interface Connector Pinout .....	20
Table 4: DC Power Connector Pinout.....	21
Table 5: AC Power Connector Pinout.....	22
Table 6: System Status LED Indicator.....	25
Table 7: RS-232 Communication Parameters .....	42
Table 8: RS-232 Error Codes .....	48
Table 9: RS-232 Setup Messages.....	50
Table 10: RS-232 Control Messages .....	63
Table 11: RS-232 Informational Messages.....	68
Table 12: System Status Byte .....	70
Table 13: Highest Base Pressures for Zero Adjustment .....	79
Table 14: Troubleshooting Chart .....	80
Table 15: RS-232 Application Specific Messages.....	87
Table 16: RS-232 Command Summary .....	95
Table 17: ASCII Value Chart.....	101



## Safety Information

### Symbols Used in This Instruction Manual

Definitions of WARNING, CAUTION, and NOTE messages used throughout the manual.

---

**Warning**  The **WARNING** sign denotes a hazard. It calls attention to a procedure, practice, condition, or the like, which, if not correctly performed or adhered to, could result in injury to personnel.

---

---

**Caution**  The **CAUTION** sign denotes a hazard. It calls attention to an operating procedure, practice, or the like, which, if not correctly performed or adhered to, could result in damage to or destruction of all or part of the product.

---

---

**Note**  The **NOTE** sign denotes important information. It calls attention to a procedure, practice, condition, or the like, which is essential to highlight.

---

## Symbols Found on the Unit

The following table describes symbols that may be found on the unit.















Definition of Symbols Found on the Unit			
			
On (Supply) IEC 417, No.5007	Off (Supply) IEC 417, No.5008	Earth (ground) IEC 417, No.5017	Protective earth (ground) IEC 417, No.5019
			
Frame or chassis IEC 417, No.5020	Equipotentiality IEC 417, No.5021	Direct current IEC 417, No.5031	Alternating Current IEC 417, No. 5032
			
Both direct and alternating Current IEC 417, No.5033-a	Class II equipment IEC 417, No.5172-a	Three phase alternating Current IEC 617-2 No. 020206	
			
Caution, refer to accompanying documents ISO 3864, No. B.3.1	Caution, risk of electric shock ISO 3864, No. B.3.6	Caution, hot surface IEC 417, No. 5041	

Table 1: Definition of Symbols Found on the Unit

## **Safety Procedures and Precautions**

**The following general safety precautions must be observed during all phases of operation of this instrument. Failure to comply with these precautions or with specific warnings elsewhere in this manual violates safety standards of intended use of the instrument and may impair the protection provided by the equipment. MKS Instruments, Inc. assumes no liability for the customer's failure to comply with these requirements.**

### **DO NOT SUBSTITUTE PARTS OR MODIFY INSTRUMENT**

Do not install substitute parts or perform any unauthorized modification to the instrument. Return the instrument to an MKS Calibration and Service Center for service and repair to ensure that all safety features are maintained.

### **SERVICE BY QUALIFIED PERSONNEL ONLY**

Operating personnel must not remove instrument covers. Component replacement and internal adjustments must be made by qualified service personnel only.

### **USE CAUTION WHEN OPERATING WITH HAZARDOUS MATERIALS**

If hazardous materials are used, users must take responsibility to observe the proper safety precautions, completely purge the instrument when necessary, and ensure that the material used is compatible with sealing materials.

### **PURGE THE INSTRUMENT**

After installing the unit, or before its removal from a system, be sure to purge the unit completely with a clean, dry, inert gas to eliminate all traces of the previously used flow material.

### **USE PROPER PROCEDURES WHEN PURGING**

This instrument must be purged under a ventilation hood, and gloves must be worn to protect personnel.

### **DO NOT OPERATE IN EXPLOSIVE ATMOSPHERES**

To avoid explosion, do not operate this product in an explosive atmosphere unless it has been specifically certified for such operation.

### **USE PROPER FITTINGS AND TIGHTENING PROCEDURES**

All instrument fittings must be consistent with instrument specifications, and compatible with the intended use of the instrument. Assemble and tighten fittings according to manufacturer's directions.

**CHECK FOR LEAK-TIGHT FITTINGS**

Before proceeding to instrument setup, carefully check all plumbing connections to the instrument to ensure leak-tight installation.

**OPERATE AT SAFE INLET PRESSURES**

This unit should never be operated at pressures higher than the rated maximum pressure (refer to the product specifications for the maximum allowable pressure).

**INSTALL A SUITABLE BURST DISC**

When operating from a pressurized gas source, a suitable burst disc should be installed in the vacuum system to prevent system explosion should the system pressure rise.

**KEEP THE UNIT FREE OF CONTAMINANTS**

Do not allow contaminants of any kind to enter the unit before or during use. Contamination such as dust, dirt, lint, glass chips, and metal chips may permanently damage the unit.

**ALLOW THE UNIT TO WARM UP**

If the unit is used to control dangerous gases, they should not be applied before the unit has completely warmed up. A positive shutoff valve can be employed to ensure that no erroneous flow can occur during warm up.

## Chapter One: General Information

### Introduction

The Type 1153A Low Vapor Pressure Source Mass-Flo<sup>®</sup> Controller (MFC) is a pressure-based measurement and control system designed to meter and control vapor from low vapor pressure liquid and solid sources directly, without the need for a carrier gas.

The system consists of two Baratron<sup>®</sup> absolute pressure transducers, a flow nozzle, a high temperature solenoid valve, and a heater block system capable of maintaining temperatures from 30° to 200° C. All-metal seals eliminate the contamination typically found with the permeation of elastomeric sealing materials. The 1153 unit, equipped with Cajon<sup>®</sup> 8-VCR<sup>®</sup> male fittings, offers options for the full scale (FS) range from 1 standard cubic centimeters per minute (sccm) to 50 standard liters per minute (slm) over a wide pressure range.

The control valve is a normally closed proportional control valve. It is *not* a positive shutoff valve; therefore, some leakage across the valve may occur. Refer to *Appendix A: Product Specifications*, page 83, for the leak integrity specifications.

---

**Caution**

**If your system cannot tolerate some leakage across the control valve, install a separate positive shutoff valve.**

---

A CPU and embedded software enable the unit to function as a Proportional-Integral (PI) controller. The controller compares the flow reading to the set point, and positions the valve to maintain, or achieve, the set point flow. An on-board CPU, used for flow and temperature control, allows the 1153 unit to be operated through either analog (0 to 5 V) or digital (RS-232) communications.

The 1153 system requires one  $\pm 15$  VDC  $\pm 5\%$  power supply @ 1 Amp to provide power to the pressure transducers and valve control circuitry, and one 24 VAC power supply @ 8 Amps to provide power to the heater.

The 1153 unit is optimized at the factory for the application parameters specified when the unit was ordered. The unit is shipped with a Calibration Data Sheet (refer to Figure 9, page 34), which lists the design parameters stored in the unit for both the calibration and user gases. If your application parameters change, contact the MKS Applications Department for new calibration data.

## **How This Manual is Organized**

This manual is designed to provide instructions on how to set up and install a 1153 unit.

**Before installing your 1153 unit in a system and/or operating it, carefully read and familiarize yourself with all precautionary notes in the *Safety Messages and Procedures* section at the front of this manual. In addition, observe and obey all WARNING and CAUTION notes provided throughout the manual.**

*Chapter One: General Information*, (this chapter) introduces the product and describes the organization of the manual.

*Chapter Two: Installation*, explains the environmental requirements and describes how to mount the instrument in your system.

*Chapter Three: Overview*, gives a brief description of the instrument and its functionality.

*Chapter Four: Analog Operation*, describes how to control the system through the Interface connector on the side panel.

*Chapter Five: RS-232 Operation*, describes the protocol and messages used to operate the unit through digital RS-232 communications.

*Chapter Six: Maintenance and Troubleshooting*, describes basic maintenance procedures and provides a checklist for reference should the instrument malfunction.

*Appendix A: Product Specifications*, lists the specifications of the instrument.

*Appendix B: Model Code Explanation*, describes the instrument's ordering code.

*Appendix C: Application Specific Parameters*, describes the RS-232 commands for the factory set application parameters.

*Appendix D: RS-232 Command Summary*, lists all of the RS-232 commands.

*Appendix E: ASCII Value Chart*, lists a standard ASCII value chart.



## **Customer Support**

Standard maintenance and repair services are available at all of our regional MKS Calibration and Service Centers, listed on the back cover. In addition, MKS accepts the instruments of other manufacturers for recalibration using the Primary and Transfer Standard calibration equipment located at all of our regional service centers. Should any difficulties arise in the use of your 1153 instrument, or to obtain information about companion products MKS offers, contact any authorized MKS Calibration and Service Center. If it is necessary to return the instrument to MKS, please obtain an ERA Number (Equipment Return Authorization Number) from the MKS Calibration and Service Center before shipping. The ERA Number expedites handling and ensures proper servicing of your instrument.

Please refer to the inside of the back cover of this manual for a list of MKS Calibration and Service Centers.

---

**Warning**

---

**All returns to MKS Instruments must be free of harmful, corrosive, radioactive, or toxic materials.**

---

This page intentionally left blank.

## Chapter Two: Installation

### How To Unpack the Type 1153 Unit

MKS has carefully packed the 1153 unit so that it will reach you in perfect operating order. Upon receiving the unit, however, you should check for defects, cracks, broken connectors, and the like, to be certain that damage has not occurred during shipment.

**Note**

---

Do *not* discard any packing materials until you have completed your inspection and are sure the unit arrived safely.

---

If you find any damage, notify your carrier and MKS immediately. If it is necessary to return the unit to MKS, obtain an ERA Number (Equipment Return Authorization Number) from the MKS Service Center before shipping. Please refer to the inside of the back cover of this manual for a list of MKS Calibration and Service Centers.

**Caution**

---

**Only qualified individuals should perform the installation and any user adjustments. They must comply with all the necessary ESD and handling precautions while installing and adjusting the instrument. Proper handling is essential when working with all highly sensitive precision electronic instruments.**

---

### Unpacking Checklist

#### *Standard Equipment*

- Type 1153 Mass Flow Controller
- Type 1153 Instruction Manual (this book)

#### *Required Equipment (customer supplied)*

- RS-232 Serial Communications Cable
- Analog Input Cable
- Power Cables

## **Product Location and Requirements**

- Ambient Temperature Range: 15° to 45° C (59° to 113° F)
- Power requirements:  $\pm 15$  VDC  $\pm 5\%$  @ 1 Amp and 24 VAC @ 8 Amps
- Ventilation requirements include sufficient air circulation
- Ensure that the 1153 controller is *not* mounted in an upside down position since particulates may accumulate on the transducer sensing diaphragms and alter the pressure readings. Refer to *Mounting Instructions*, page 16, for more information.
- Install a separate positive shutoff valve if your system cannot tolerate some leakage across the control valve. The normally closed, proportional control valve in the 1153 system is *not* a positive shutoff valve; therefore, some leakage across the valve may occur.

### **Warning**



---

**Follow your corporate policy for handling toxic or hazardous gases. Your corporate policy on handling these gases supersedes the instructions in this manual. MKS assumes no liability for the safe handling of such materials.**

---

- Take care not to expose the transducer to pressures above its full scale range. Pressures exceeding 35 psia, or 120% of the FS sensor range, whichever is greater, may damage the transducer.
- Keep the 1153 unit bagged prior to installation. The unit is bag packaged in a clean room environment. It is important to protect the unit's Cajon 8-VCR male fittings since damaged seal surfaces may leak.

## Setup

### Dimensions

**Note**

All dimensions are listed in inches with millimeters referenced in parentheses.

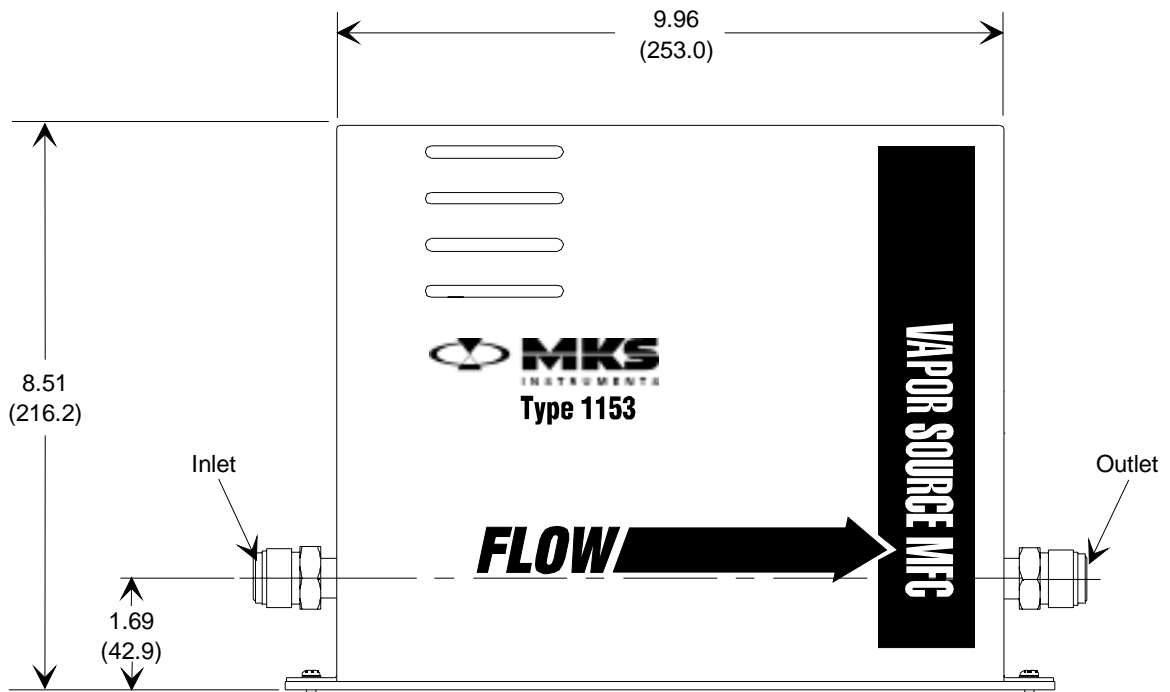

Figure 1: Front Panel Dimensions

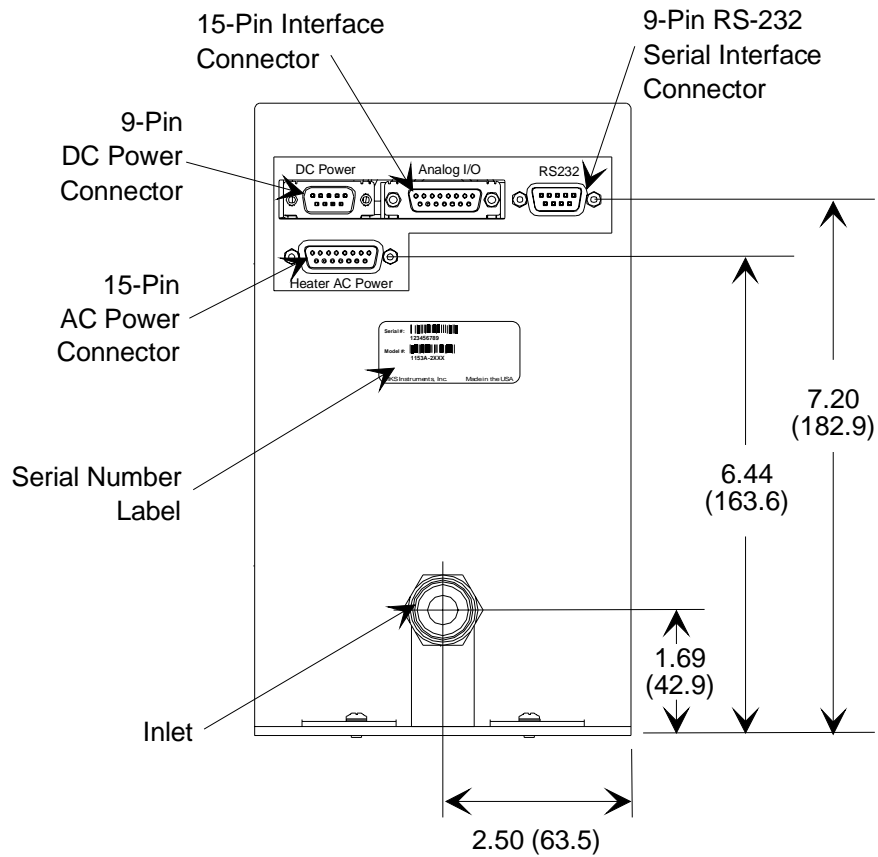

Figure 2: Side Panel Dimensions

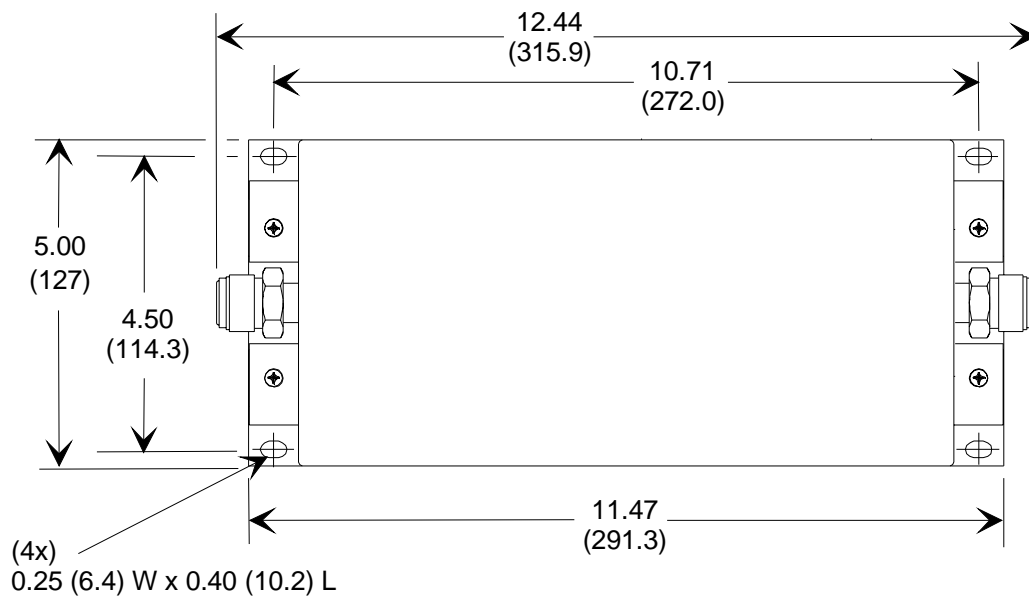

Figure 3: Baseplate Dimensions

## Power Requirements

The 1153 system requires one  $\pm 15$  VDC  $\pm 5\%$  power supply @ 1 Amp to provide power to the pressure transducers and valve control circuitry, and one 24 VAC power supply @ 8 Amps to provide power to the heater.

## Operating Temperature

The system operating temperature must be high enough to prevent condensation of the vaporized source and lower than its decomposition temperature. The operating temperature ranges from 30° to 200° C and is factory set through either an analog or digital (RS-232) set point.

The factory set operating temperature for your application is listed on the Warning Label, located on the rear panel of the 1153 unit (refer to Figure 6, page 18).

### Caution



---

**To prevent condensation of the vaporized source, provide a positive temperature gradient to the process. The temperature of all source lines should be less than or equal to the 1153 unit's operating temperature.**

---

## Gas Source

### *Maximum Inlet Pressure*

Applications with a large differential pressure between the inlet and outlet, or a large inlet pressure, may require special precautions:

- Ensure that the valve will never be fully opened to the transducer if the inlet pressure is greater than 35 psia, or 120% of the FS sensor range, whichever is greater.

### Caution



---

**Take care not to expose the transducer to pressures above its full scale range. Pressures exceeding 35 psia or 120% of the full scale sensor range, whichever is greater, may damage the transducer.**

---

- Ensure that the force resulting from the pressure differential across the valve does not inhibit valve movement. For example, a closed valve may be unable to open.

The maximum allowable pressure differential across the valve is a function of the orifice size in the valve; higher differential pressures are allowed for smaller orifices.

Consult the factory for more information regarding applications with large differential pressures.

### Source Feed Line Temperature

It is critically important for consistent system operation that the source feed lines be adequately heated and insulated, as shown in Figure 4. **Remember, the coolest point in the system must be the source.** As integral parts of the feed lines, the up- and downstream shutoff valves must also be heated and insulated.

While MKS Instruments has very accurately temperature controlled the entire 1153 unit, failure to provide heat to all parts of the system may cause condensation which is detrimental to proper system operation.

#### Warning



Operating at temperatures above the flash point of the vapor may cause combustion to occur if a leak to atmosphere is present. Refer to the instrument's Warning Label, shown in Figure 12, page 38, for the factory set temperature for your application.

#### Caution



1. The system temperature must not exceed the decomposition temperature of the vapor source material.
2. Failure to heat all parts of the system may cause condensation, insufficient flow, or oscillation.

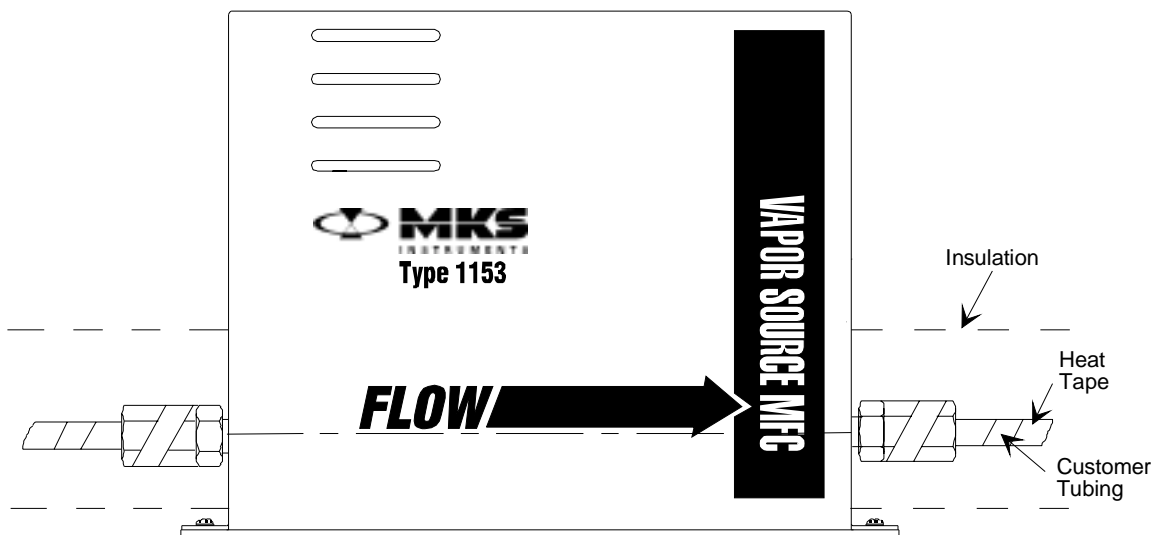

Figure 4: Typical Source Feed Line Setup



### ***Source Feed Line Conductance***

To minimize vapor condensation and to ensure that the 1153 unit will operate at full rated flow, *use the largest possible I.D. piping*. The unit is equipped with Cajon 8-VCR male fittings to be used with ½ inch tubing. This diameter is adequate (ID ≥ 0.40”) for most installations. If ½ inch tubing is being used, shutoff valves should be of the highest available conductance. Examples are ball valves or barstock type valves such as the NUPRO® SS8BK.

Ensure that the downstream conductance matches the conductance stated at the time of order. Decreasing downstream conductance may reduce the performance of the instrument.

---

**Caution**

**Ensure that the operating conditions closely match the configuration specified at the time the 1153 unit was ordered. If there are any deviations in the configuration, contact the factory before operating the unit.**

---

## Mounting Instructions

### Warning



---

Read and follow all messages in *Safety Procedures and Precautions*, page 3, **BEFORE** attempting to install the 1153 unit. Failure to adhere to these messages could result in injury to personnel.

---

### Caution



---

Ensure that the 1153 controller is *not* mounted in an upside down position since particulates may accumulate on the transducer sensing diaphragms and alter the pressure readings.

---

Refer to Figure 5, page 17, for a typical system configuration.

To mount the 1153 unit:

1. Ensure that all valves between the unit and the vapor source are closed.
2. Ensure that you connect the input fitting to the vapor source, and the output fitting to the downstream side.

Refer to Figure 1, page 11, for the location of the inlet and the outlet fittings.

3. Allow clearance for access to the connectors.

Straight, shielded connectors require approximately 3" (76.2 mm) height. Right angle connectors require approximately 2" (50.8 mm) height.

4. Place the 1153 unit into position in the gas stream such that the flow will be in the direction of the arrow on the side of the controller.

The 1153 unit is calibrated while in a vertical position (refer to Figure 1, page 11).

Placement of the flow components in an orientation other than that in which they were calibrated (such as horizontal) may cause a small zero shift in the pressure readings.

Refer to *How To Adjust the Transducer Zero*, page 79, for information on adjusting the transducer zero.

5. Secure the 1153 unit in place.

The baseplate of the unit has ¼" slots to accommodate the mounting screws. Refer to Figure 3, page 12.

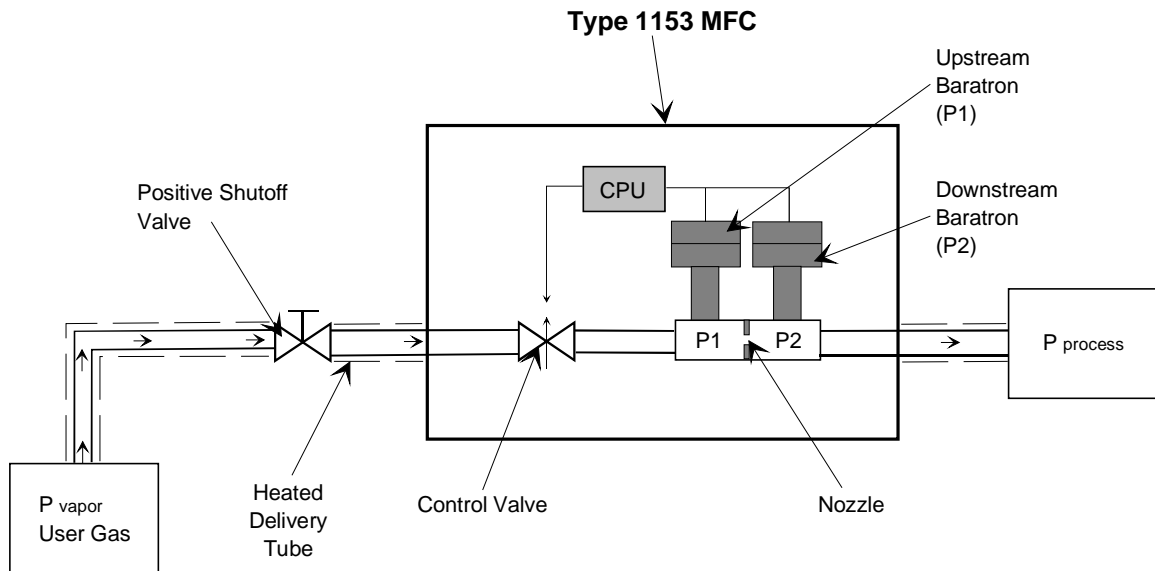

Figure 5: Typical System Configuration

**Caution**

**Install a separate positive shutoff valve if your system cannot tolerate some leakage across the control valve. The normally closed, proportional control valve in the 1153 system is *not* a positive shutoff valve; therefore, some leakage across the valve may occur.**

## Connectors

The RS-232 digital communications connector and the Type “D” Interface, DC Power, and AC Power connectors are located on the side of the unit (refer to Figure 2, page 12). Pinouts for these connectors are listed on the rear panel of the instrument, as shown in Figure 6. The pinouts for these connectors are also listed in Tables 2 through 5, pages 19 through 22.

### Note



The “Reserved” and “No Connection” pin assignments for the connectors are defined as follows:

1. The “Reserved” pin assignment refers to a pin which has an internal connection and may be assigned a function in the future.
2. The “No Connection” pin assignment refers to a pin with no internal connection.

### Caution



To prevent damage from electrostatic discharge (ESD) to the sensitive connector pins, they must be covered with an ESD protective cover when not in use.

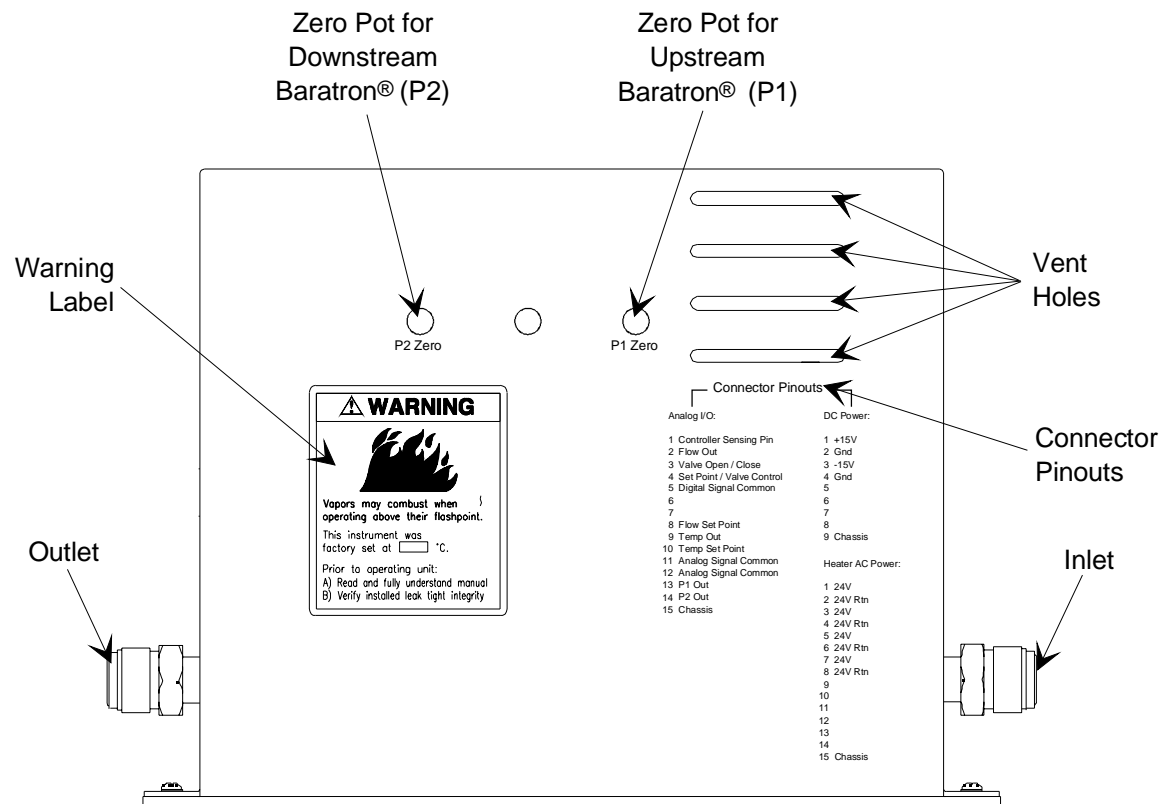

Figure 6: Rear Panel of the 1153 Unit

**RS-232 Serial Interface Connector**

The 9-pin digital communications connector provides an interface for RS-232 communications.

<b>RS-232 Serial Interface Cable Pinout</b>	
<b>Pin Number</b>	<b>Assignment</b>
1	No Connection
2	Transmit data
3	Receive data
4	No Connection
5	Digital ground
6	Reserved
7	Reserved
8	No Connection
9	No Connection

Table 2: RS-232 Serial Interface Connector Pinout

## Interface Connector

The 15-pin male Type “D” Interface (Analog I/O) connector provides the pressure output, set point input, and trip point output signals.

Interface Connector Pinout		
Pin Number	Assignment	Function
1	Controller Sensing Pin	Identifies whether an analog controller is being used; instructs the unit that an analog cable is attached to the unit. Ground this pin to the digital ground (of the control system).
2	Flow Output Signal	Analog output signal (0 to 5 V) for the flow rate.
3	Valve Open/Close	User supplied digital control signal. If Pin 4 is LOW, this pin controls whether valve is open (HIGH) or closed (LOW). If Pin 4 is HIGH, this pin is ignored.
4	Set Point/Valve Control	User supplied digital control signal. If this pin is LOW, Pin 3 is monitored to open or close the valve. If this pin is HIGH, the unit controls the flow to the set point on Pin 8.
5	Digital Signal Common	Connect this pin to the digital ground of the control system.
6	No Connection	None
7	No Connection	None
8	Flow Set Point	Analog input signal (0 to 5 V) for the flow rate set point. If Pin 4 is LOW, this pin is ignored.
9	Temperature Output Signal	Analog output signal (0 to 5 V) for the 1153 temperature. The scale factor is user-defined; (factory default: 1 V = 100° C).

Table 3: Interface Connector Pinout  
(Continued on next page)

<b>Interface Connector Pinout (Continued)</b>		
<b>Pin Number</b>	<b>Assignment</b>	<b>Function</b>
10	Temperature Set Point	Analog input signal (0 to 5 V) for the temperature set point. The scale factor is user-defined; (factory default: 1 V = 100° C).
11	Analog Ground	Connect this pin to the analog ground of the control system.
12	Analog Ground	Connect this pin to the analog ground of the control system.
13	P1 Output Signal	Analog output signal (0 to 10 V) for the upstream Baratron transducer (P1).
14	P2 Output Signal	Analog output signal (0 to 10 V) for the downstream Baratron transducer (P2).
15	Chassis Ground	Connect this pin to the chassis ground of the control system.

Table 3: Interface Connector Pinout

### DC Power Connector

The  $\pm 15$  VDC power connector (J9) is a 9-pin male Type “D” connector which provides power to the pressure transducers and valve control circuitry.

<b>DC Power Connector Pinout</b>	
<b>Pin Number</b>	<b>Assignment</b>
1	+15 VDC
2	Ground
3	-15 VDC
4	Ground
5	No Connection
6	No Connection
7	No Connection
8	No Connection
9	Chassis Ground

Table 4: DC Power Connector Pinout

### AC Power Connector

The +24 VAC power connector is a 15-pin Type “D” connector which provides power to the heater. The pins are connected internally. All four pins (either pins 1, 3, 5, and 7, or 2, 4, 6, and 8) must be used; using fewer than the four assigned pins may cause too high a current on an individual pin.

<b>AC Power Connector Pinout</b>	
<b>Pin Number</b>	<b>Assignment</b>
1	+24 VAC
2	+24 V Return
3	+24 VAC
4	+24 V Return
5	+24 VAC
6	+24 V Return
7	+24 VAC
8	+24 V Return
9	No Connection
10	No Connection
11	No Connection
12	No Connection
13	No Connection
14	No Connection
15	Chassis Ground

Table 5: AC Power Connector Pinout



## **Start Up**

### **Warning**



---

**Read and follow all safety messages listed in *Safety Procedures and Precautions*, page 3, BEFORE attempting to operate the 1153 unit. Failure to adhere to these messages could result in injury to personnel.**

---

To start up the 1153 MFC:

1. Ensure that all gas and electrical connections are made.
2. Thoroughly evacuate all gas lines to remove water adsorbed on the exposed areas.
3. Leak check the entire system.
4. Connect the cables and allow the system to warm up.
5. Clear the system reset bit (*digital operation only*).

When the unit is powered up, the reset bit (bit 0) in the system status byte is set to “1”, indicating that the system has been reset. You should clear this status flag by resetting the value of the bit to “0”, using the RS-232 Status Reset “SR\_” command. Resetting the bit to zero allows you to monitor whether the unit loses power or has been reset.

Refer to *How To Clear the Reset Bit*, page 71, for more information.

## Default Operating Mode

The 1153 instrument defaults to the Analog mode each time it is powered up. Once ON, the instrument immediately reads pin 10 on the Interface connector (refer to Table 3, page 20), to establish the temperature set point. Refer to *Chapter Four: Analog Operation*, page 39, for more information on analog operation of the 1153 unit.

If you want to operate the 1153 unit as a digital device, you must perform the following two steps *each time power is introduced to the system*:

1. Issue the Comm State Flag “CSF” command, which changes the communication state of the unit from analog to digital.

The “CSF” command is the *only* RS-232 message which is accepted in the Analog mode. Refer to *How To Set the Comm State Flag*, page 52, for additional information.

2. Set the Temperature Set Point, using the “TSP” command.

Refer to *How To Set the Temperature Set Point*, page 65, for more information.

Refer to *Chapter Five: RS-232 Operation*, page 41, for complete information on digital operation of the 1153 unit.

### Caution



---

**If an electrostatic discharge (ESD) occurs near the 1153 unit, the unit may reset itself and revert to the Analog mode.**

---

## Warm Up Time

The unit requires a minimum of four (4) hours to warm up. Although the indicated temperature may stabilize at the desired operational temperature within 1 to 2 hours, a full 4 hours is required for the entire unit to stabilize.

During the warm up period the temperature of the MFC may overshoot the set point temperature by a few degrees. Therefore, the temperature output pin (pin 9 on the Interface connector) may indicate an “above operating temperature status” for several minutes. Refer to Table 3, page 20, for the Interface connector pinout.

### Note



---

MKS recommends that the instrument be powered at all times. Continuous power to the unit eliminates the need allow a minimum of 4 hours for the unit to reach the operating temperature and reduces the thermal stress of sensitive components as the unit heats and cools.

---

## Status LED

To provide operation status, the 1153 unit is equipped with an internal LED, which is visible through the vent holes on the rear instrument panel (refer to Figure 6, page 18). When the unit is functioning properly the LED flashes green, approximately once a second. If the CPU detects an error (such as an over temperature error), the LED flashes red. If the CPU stops functioning, the LED stops flashing and may remain either on or off.

System Status LED Indicator	
LED State	Meaning
Flashing Green	System functioning normally
Flashing Red	Error detected by CPU
Solid Green or Red	CPU not functioning
OFF	CPU not functioning; system powered down

Table 6: System Status LED Indicator

### Note



If an error is detected by the CPU causing the LED to flash RED, it will continue flashing red even after if the error is corrected. You must cycle power to the unit off and on to reset the LED to flashing green.

This page intentionally left blank.

## Chapter Three: Overview

### Functional Description

The operation of the 1153 system is based on flow equations for a compressible gas across an orifice. Two pressure transducers of appropriate range measure these pressures; the CPU calculates the resulting flow rates and generates an output voltage which is appropriately scaled to give a 0 to 5 VDC output equal to 0 to 100% FS flow of the specified material. The output signal and the set point signal are compared by the CPU using a Proportional-Integral (PI) control algorithm. An error signal (the difference between the set point signal and the actual signal) is generated, and after further control calculations, a drive current for the proportioning flow control valve is generated which opens the valve to the correct position for the desired flow rate.

The stability and accuracy of the delivery system depends heavily on the proper integration of the 1153 MFC, the power supply, the source heater, and the source feed lines.

### Mass Flow Measurement Theory

Sonic, or choked-viscous, flow is obtained when the ratio of the upstream to downstream pressures across an orifice is greater than some critical value. For ideal gases with constant specific heats, this critical pressure ratio is given by:

$$\left( \frac{P_1}{P_2} \right)_{critical} = \left( \frac{k+1}{2} \right)^{\frac{k}{k-1}}$$

where:  $P_1$  = absolute pressure immediately upstream of the orifice  
 $P_2$  = absolute pressure immediately downstream of the orifice  
 $k$  = ratio of specific heats for the gas

For most gases this critical pressure ratio is approximately equal to 2. Therefore, if the upstream pressure is at least twice the downstream pressure, the flow is sonic. For sonic flow, the mass flow rate is independent of the downstream pressure and is directly proportional to the upstream pressure:

$$q = CAP_1 \sqrt{\frac{1}{MT}} \times f(k)$$

where: q = mass flow rate (sccm)  
C = discharge coefficient (a function of the nozzle geometry and other factors)  
A = area of the orifice opening  
M = molecular weight of the gas  
T = absolute temperature of the gas, K, or R

When the pressure ratio is less than the critical ratio, the flow is non-choked, and the mass flow rate becomes a function of downstream pressure. Specifically:

$$q = CAP_1 \sqrt{\frac{1}{MT}} \times f\left(k, \frac{P_1}{P_2}\right)$$

The gas properties (M and k) as well as the nozzle diameter (for calculating the area) are entered using RS-232 commands and are stored in permanent memory (EEPROM). When the unit is calibrated before shipping, the values of the experimentally determined discharge coefficient are entered and stored in the EEPROM. During operation, the CPU monitors the temperature and the upstream and downstream pressures, determines whether the flow is choked or not, and then uses the appropriate flow equation for calculating the mass flow rate across the orifice.

---

**Note**

For improved performance near zero flow conditions, the calculated flow rate is set to zero if the pressure ratio ( $P_2/P_1$ ) exceeds 0.9975.

---

## **Proportional - Integral (PI) Control Theory**

The calculated flow rate is compared to the flow set point, and the error between the two is determined. The PI control algorithm updates the signal to the valve based on the error as follows:

1. PROPORTIONAL control gives a valve signal (current) that is proportional to the error.
2. INTEGRAL control gives a valve response that is proportional to the integral of the error with respect to time.

The 1153 control algorithm combines the integral and proportional control adjustments into the valve control parameter  $G$  (*Gain*). An additional multiplier for the proportional adjustment is included with the valve control parameter  $E$  (*Phase Lead*). The parameter  $E$  allows the controller to compensate for the lag in the control system. In the case of the 1153 MFC, this lag is caused by restrictions in the gas flow path and the pressurized volume between the valve and flow orifice.

The control parameters  $E$  and  $G$  are set at the factory for optimal system response. The typical values of  $E$  are between 0 and 0.2 seconds. The values of  $G$  vary more for different applications, but are typically between 0.1 and 10. The response behavior is a relatively weak function of the parameter  $E$  in that the optimal value of  $E$  does not vary much for different flow conditions.

The response is a stronger function of the gain  $G$ . The optimal value of  $G$  is a function of the gas being used, the inlet pressure, and the temperature. To a first order approximation:

$$G \sim \frac{1}{P_{inlet}} \sqrt{\frac{M}{T}}$$

Therefore, if switching to a gas with a different molecular weight or changing the inlet pressure, the gain should be modified as appropriate. In general, if the observed flow response becomes unstable and the valve starts to oscillate, try reducing the gain. If the flow response is too slow, try increasing the gain. Refer to *How To Set the Valve Control Parameters*, page 56, for more information.

To help speed the response of the 1153 unit, information regarding the flow rate versus valve current is supplied to the CPU during calibration. A typical curve of flow rate versus valve current is shown as the solid line in Figure 7.

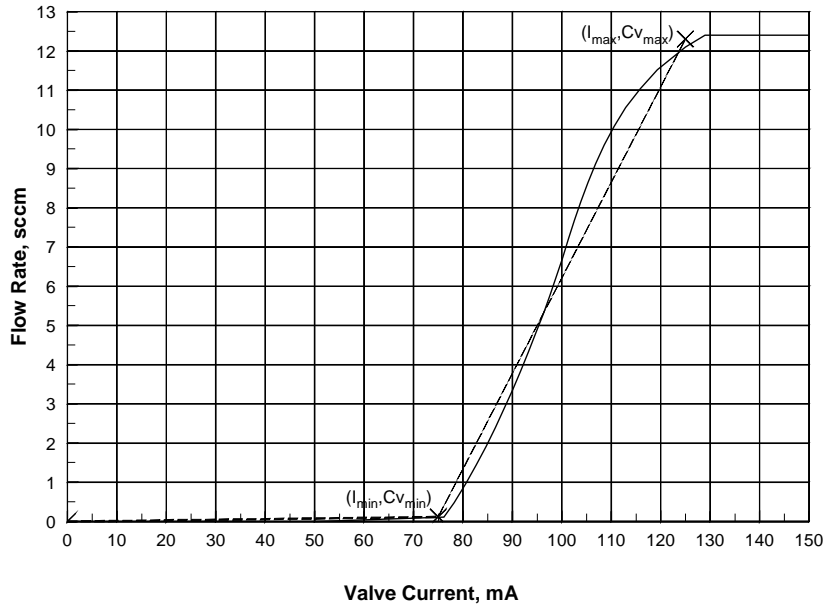

Figure 7: Flow Rate Versus Valve Current

As the current is increased from zero, there is a long region where no flow is observed. In this region, the valve current is overcoming the preload force tending to keep the valve closed. Once the magnetic forces balance this preload, the flow increases as the current is further increased. At some point, the magnetic force becomes so great that the valve snaps open and no further increase in the flow rate occurs.

The dashed line shows how the actual curve is approximated by the CPU. The point where the valve pops full open is approximated by the point  $(I_{\max}, C_{v_{\max}})$  where  $I_{\max}$  is the current in mA and  $C_{v_{\max}}$  is an estimate of the maximum conductance of the valve in liters/sec (the maximum conductance is a measure of the maximum obtainable flow rate through the valve). The point where the valve first opens is approximated by the point  $(I_{\min}, C_{v_{\min}})$ . In this case,  $C_{v_{\min}}$  is typically set to  $C_{v_{\max}}/100$ . When the flow controller determines the valve current required to obtain a given flow set point, it will attempt to use a current between  $I_{\min}$  and  $I_{\max}$ . This helps to speed the response of the MFC because currents between 0 and  $I_{\min}$  are skipped over.



The minimum and maximum valve currents and conductances for the calibration and user gases are provided on the *1153A Calibration Parameters* data sheets (refer to Figure 10, page 36, and Figure 11, page 37) that are shipped with each unit. The valve current limits do not change with changing process conditions. The valve conductances are a function of the gas, temperature, and valve geometry. As a first order approximation, the functional form of the maximum valve conductance is given by:

$$C_{v_{\max}} \sim \sqrt{\frac{T}{M} k \left( \frac{2}{k+1} \right)^{\frac{k+1}{k-1}}}$$

If the temperature or gas changes, the values of  $C_{v_{\min}}$  and  $C_{v_{\max}}$  should be updated accordingly. Refer to *How To Set the Valve Conductance Levels*, page 57, for more information.

## Valve Orifice Size

The 1153 controller is available in nine valve orifice sizes. The valve orifice, combined with the sonic nozzle, establishes the pressure drop across the instrument. The valve orifice and nozzle are sized according to the process parameters provided to MKS when you ordered the 1153 unit. If your process parameters vary from the original parameters, it may be necessary to change the valve orifice size. Consult the MKS Applications Department for assistance.

### Note



The orifice is not adjustable and is only replaceable at the factory.

## Flow Control Range

The flow control range of the 1153 controller varies, depending upon the upstream pressure ( $P_1$ ) and downstream pressure ( $P_2$ ) of the application. Figure 8, shows the general effect of downstream pressure on the control range. When the system has no downstream pressure ( $P_2 = 0$ ), the ideal flow versus upstream pressure is linear over the entire flow range. When the downstream pressure is greater than 0, the flow decreases to zero when the upstream pressure equals the downstream pressure.

The flow versus upstream pressure becomes steep as  $P_1$  approaches  $P_2$ . Consequently, it becomes more difficult to accurately control. For typical applications a control range of at least 10% to 100% of full scale is achievable. Consult the MKS Applications Department for data relative to your specific operating conditions.

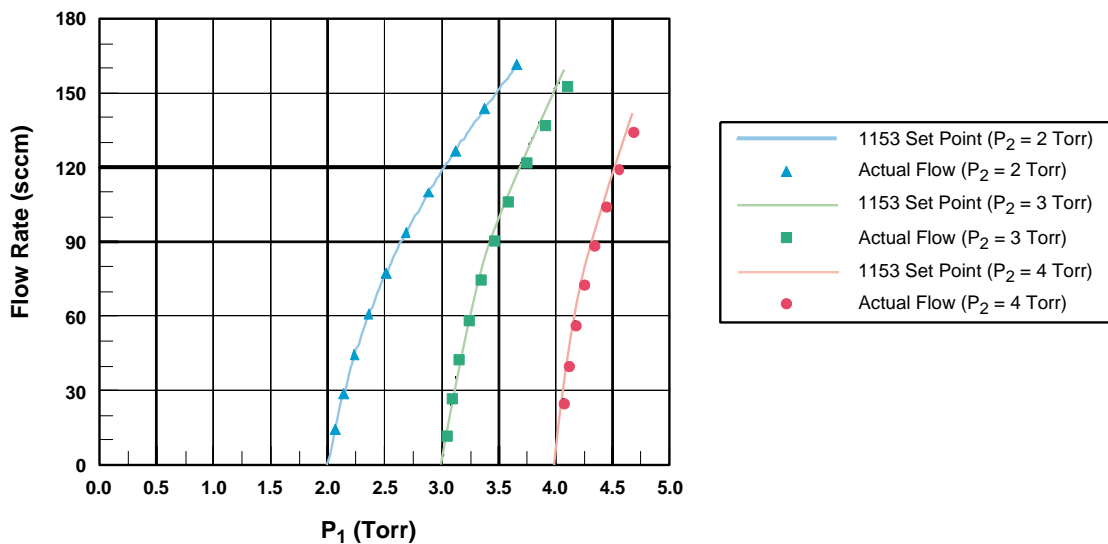

Figure 8: Typical Effects of Downstream Pressure ( $P_2$ ) on the Control Range

## **Calibration**

Each 1153 unit is calibrated at its normal operating temperature, using the process parameters specified during the ordering process. The data collected during the calibration is transformed into calibration constants which are fed back into the 1153 unit, and stored in memory for use by the CPU. The pressure transducers are checked for linearity and repeatability, and adjusted as necessary.

---

**Note**

The 1153 unit is calibrated at the temperature and process pressure specified at the time it was ordered. If the flow conditions (operating temperature, inlet pressure, or process gas) must change, contact the MKS Applications Department for information on updating the calibration data.

---

The customer specified process pressure is maintained at the outlet of the instrument. The vapor pressure of the source material is simulated at the inlet port, and the equivalent N<sub>2</sub> flow rates for each of the cardinal set points (10%, 20%, ...100% FS) are put through the unit. Calibration constants are generated for each of these set points and stored in memory for use by the CPU. Refer to *How To Setup the Calibration Constant Table*, page 61, for instructions on how to enter the calibration point information.

### Calibration Data Sheet

Each 1153 system is shipped with a Calibration Data Sheet, shown in Figure 9, which contains important information on the specific application for which your unit was designed.



---

**1153A FINAL CALIBRATION DATA**

CUSTOMER: \_\_\_\_\_ DATE: 03/26/97

SERIAL #: \_\_\_\_\_ MODEL: 1153A-2xxx

GAS: Mercury (Hg) SP: \_\_\_\_\_

CALIBRATION GAS: Nitrogen OPERATING TEMPERATURE: 200° C

Flow Set Point (%)	Cal Gas Set Point (sccm)	Actual Flow Rate (sccm)	P1 (Torr)	P2 (Torr)
10	12.5	12.6	2.123	2.008
20	25.0	24.8	2.416	2.017
30	37.5	37.4	2.831	2.025
40	50.0	50.2	3.334	2.033
50	62.5	62.5	3.916	2.041
60	75.0	74.9	4.528	2.049
70	87.5	87.3	5.139	2.057
80	100.0	100.1	5.756	2.065
90	112.5	112.5	6.360	2.073
100	125.0	125.1	6.975	2.081

MFC STD: \_\_\_\_\_ Std. S/N: \_\_\_\_\_

Inlet Pressure: 8 Torr Source Temp.: 180° C

Outlet Pres.: 2 Torr Checked By: \_\_\_\_\_

Figure 9: Example Calibration Data Sheet

## Calibration Parameters

The embedded calibration (control) parameters which define a specific application are listed on two *1153A Calibration Parameters* data sheets that are shipped with each 1153 unit. These data sheets (shown in Figure 10, page 36, and Figure 11, page 37), list the control parameters for the calibration gas (typically nitrogen) and the user gas.

For all applications, a computer modeling program developed by MKS is used to help configure the 1153 unit to best suit the process parameters. In the following example, a *fictitious 1153 unit configuration* will be defined to show how a typical application is developed. In our example, nitrogen (N<sub>2</sub>) is used as the calibration gas, and the user gas is mercury (Hg).

Our fictitious 1153 unit is designed for flowing 50 sccm mercury (Hg) at a temperature of 200° C. The source temperature for the Hg is 180° C, where the vapor pressure is about 8 Torr. For this design, the modeling program selected the largest valve orifice and a 0.064 inch nozzle diameter. The unit was calibrated at the factory with N<sub>2</sub> with an equivalent flow rate of approximately 125 sccm. The discharge coefficients were measured for N<sub>2</sub> at each of the cardinal set points and they were estimated for Hg based on the results for N<sub>2</sub> and the differences between N<sub>2</sub> and Hg.

---

### Note



1. The data used in the example commands in *Chapter Five: RS-232 Operation*, page 41, and in *Appendix C: Application Specific Parameters*, page 87, are based on the calibration parameters shown in Figure 10, page 36, and Figure 11, page 37.
  2. In the examples, we assume that the user gas (Hg) values are currently stored in the 1153 unit and that the user wants to switch to the calibration gas (N<sub>2</sub>) values. Therefore, in the example queries the response data will be values for Hg and in the example commands the data sent will be for N<sub>2</sub>.
-

## MKS Instruments 1153A Calibration Parameters

Serial Number	Sample Configuration	Gas used	Mercury (Hg)
<b><u>Gas Properties:</u></b>			
Molecular Weight, M (gr/mol)	200.6	Ratio of Specific Heats, K	1.67
<b><u>Flow Control:</u></b>			
Max. Valve Current (mA)	117	Max. Valve Conductance (l/s)	0.42
Min. Valve Current (mA)	68	Min. Valve Conductance (l/s)	0.0042
Analog FS Range (sccm/5 V)	50	Valve Control Parameter E	0.13
		Valve Control Parameter G	1.67
<b><u>Communication Parameters:</u></b>			
Baud Rate	9600	Unit's Address (ID)	254
<b><u>Temperature Control:</u></b>			
Temperature Set Point (° C)	200	Temp. Control Parameter E	900
Analog FS Temp. Range (° C/5 V)	500	Temp. Control Parameter G	0.01
Max. Temperature (° C)	205		
<b><u>1153 Design:</u></b>			
Nozzle Diameter (in.)	0.064	Flow Set Point (sccm)	50
Upstream Baratron (P1)		Downstream Baratron (P2)	
Range (Torr)	10	Range (Torr)	10
Gain	1	Gain	1
Offset	0	Offset	0
<b><u>Discharge Coefficients versus Flow Rate:</u></b>			
100% Flow Rate (sccm)	50		
0%	0.585	60%	0.713
10%	0.585	70%	0.730
20%	0.615	80%	0.742
30%	0.643	90%	0.753
40%	0.669	100%	0.761
50%	0.692		

Figure 10: Example Calibration Parameter Data Sheet - User Gas

## MKS Instruments 1153A Calibration Parameters

Serial Number	Sample Configuration	Gas used	Nitrogen
<b><u>Gas Properties:</u></b>			
Molecular Weight, M (gr/mol)	28	Ratio of Specific Heats, K	1.39
<b><u>Flow Control:</u></b>			
Max. Valve Current (mA)	117	Max. Valve Conductance (l/s)	1.05
Min. Valve Current (mA)	68	Min. Valve Conductance (l/s)	0.0105
Analog FS Range (sccm/5 V)	125	Valve Control Parameter E	0.01
		Valve Control Parameter G	0.67
<b><u>Communication Parameters:</u></b>			
Baud Rate	9600	Unit's Address (ID)	254
<b><u>Temperature Control:</u></b>			
Temperature Set Point (° C)	200	Temp. Control Parameter E	900
Analog FS Temp. Range (° C/5 V)	500	Temp. Control Parameter G	0.01
Max. Temperature (° C)	205		
<b><u>1153 Design:</u></b>			
Nozzle Diameter (in.)	0.064	Flow Set Point (sccm)	125
Upstream Baratron (P1)		Downstream Baratron (P2)	
Range (Torr)	10	Range (Torr)	10
Gain	1	Gain	1
Offset	0	Offset	0
<b><u>Discharge Coefficients versus Flow Rate:</u></b>			
100% Flow Rate (sccm)	125		
0%	0.524	60%	0.686
10%	0.524	70%	0.705
20%	0.562	80%	0.720
30%	0.597	90%	0.732
40%	0.631	100%	0.742
50%	0.661		

Figure 11: Example Calibration Parameter Data Sheet - Calibration Gas

## Labels

### Warning Label

The warning label, located on the rear panel of the unit (refer to Figure 6, page 18), lists the factory set operating temperature for your application.

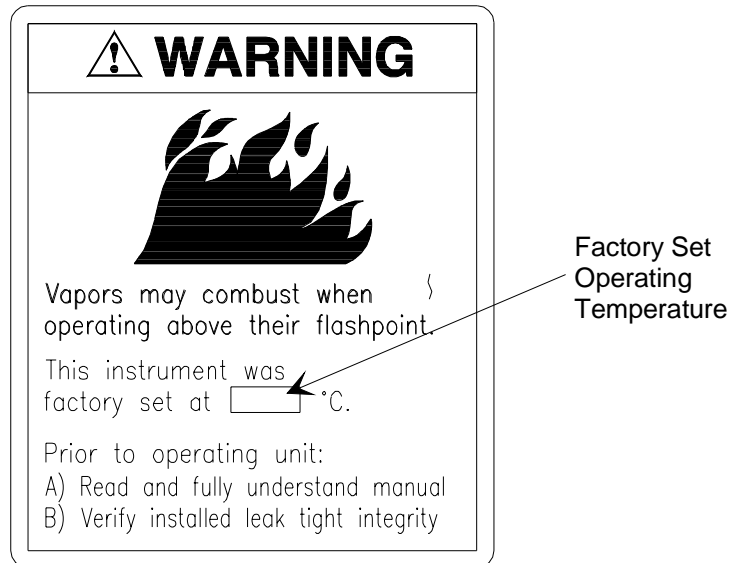

Figure 12: Warning Label

### Serial Number Label

The serial number label, located below the connectors on the side panel of the unit (refer to Figure 2, page 12), lists the unit's serial and model numbers.



Figure 13: Serial Number Label

The instrument is identified as “1153A-2XXX”, where:

- 1153A = Product Type
- 2XXX = Configuration

Refer to *Appendix B: Model Code Explanation*, page 85, for more information.



## Chapter Four: Analog Operation

### General Information

Analog control of the 1153 unit is accomplished through the 15-pin Type “D” Interface connector, located on the side panel of the instrument (refer to Figure 2, page 12). Refer to Table 3, page 20, for the Interface connector pinout.

**Note**

---

The temperature and flow set points, and the type of valve control can be set through the Interface connector. All other control parameters must be set using digital RS-232 commands.

---

The 1153 instrument defaults to the Analog mode when it is powered up. A full 4 hours is required for the entire unit to warm up and stabilize. Refer to *Warm Up Time*, page 24, for additional information. Once the unit is ON, the instrument immediately reads pin 10 on the Interface connector to establish the temperature set point. The CPU then compares the current temperature to the set point and adjusts the power supplied to the heaters to reach and maintain the set point.

When you use the MFC as an analog device, the *only* RS-232 *command* which is accepted is the Comm State Flag “CSF” command, which allows you to change the communication state from analog to digital. All other RS-232 commands will return an *Invalid Operating Mode* error message; however, all RS-232 *requests* will be accepted. Refer to *Chapter Five: RS-232 Operation*, page 41, for more information on digital operation.

### How To Set the Temperature Set Point

To set the temperature set point, apply a voltage from 0 to 5V to pin 10 on the Interface connector. The factory set scale factor is  $1\text{ V} = 100^\circ\text{ C}$ .

Refer to *How To Set the Temperature Set Point*, page 65, for information on changing the temperature set point with a RS-232 command.

## **How To Set the Flow Set Point**

To set the flow set point in sccm, apply a voltage from 0 to 5V to pin 8 on the Interface connector. The factory set scale factor is  $1\text{ V} = 100^\circ\text{C}$ .

Refer to *How To Set the Flow Set Point*, page 64, for information on changing the flow set point with a RS-232 command.

## **How To Control the Operation of the Valve**

Pins 3, 4, and 8 on the Interface connector control the operation of the valve inside of the 1153 unit. Pin 4 controls whether the unit will use direct valve control (set with Pin 3) or whether the unit will control the valve based on the flow set point (set with Pin 8). The digital control signal is user supplied.

Refer to *How To Control the Operation of the Valve*, page 67, for information on changing the valve control using RS-232 commands.

### **How To Open the Valve**

To open the valve:

1. Set Pin 4 LOW.  
Pin 8 is ignored.
2. Set Pin 3 HIGH.

### **How To Close the Valve**

To close the valve:

1. Set Pin 4 LOW.  
Pin 8 is ignored.
2. Set Pin 3 LOW.

### **How To Set the Valve to Control to the Flow Set Point**

To control the valve position based on the flow set point:

1. Set Pin 4 HIGH.  
Pin 3 is ignored.

## Chapter Five: RS-232 Operation

### General Information

Digital control of the 1153 unit is accomplished through the 9-pin RS-232 Serial Interface connector, located on the side panel of the instrument (refer to Figure 2, page 12).

The 1153 instrument defaults to the Analog mode each time it is powered up. To use the MFC as a digital device you must ensure that the communication state is set to the Digital mode, and that the temperature set point is established, as described in *Start Up*, page 23.

---

**Warning**

**Read and follow all safety messages listed in *Safety Procedures and Precautions*, page 3, BEFORE attempting to operate the 1153 unit. Failure to adhere to these messages could result in injury to personnel.**

---

The digital RS-232 communication commands are separated into 3 functional groups: Setup, Control, and Informational. Use the Setup messages to review and adjust the operating parameters including the system's full scale flow, system temperature, flow constants, and setup of the calibration constant table. Use the Control messages to set the flow and temperature set points, and to control the temperature controller and valve position. Use the Informational messages to report the system flow, temperature, and pressure, as well as to query some of the non-adjustable system features.

An additional group of RS-232 commands, set and optimized by the factory for your specific application, are described in *Appendix C: Application Specific Parameters*, page 87.

**RS-232 Communication Parameters**

The RS-232 interface supports 1,200; 2,400; 4,800, and 9,600 baud. The RS-232 communications parameters listed in Table 7 are factory set and, except for the baud rate, cannot be adjusted.

<b>RS-232 Communication Parameters</b>	
<b>Parameter</b>	<b>Value</b>
Start Bit	1
Data Bits	8
Parity	No parity
Stop Bit	1
Baud Rate*	1,200; 2,400; 4,800, 9,600 (initial)
End-of-Line Delimiter	semicolon (;)
* User-adjustable	

Table 7: RS-232 Communication Parameters

## **RS-232 Protocol**

All RS-232 messages used by the mass flow controller are composed of variable length ASCII strings. Messages sent to the unit from a remote computer are either *commands* that instruct the instrument to change an operating parameter, or *requests* that prompt the instrument to report information. Messages sent by the unit to a remote computer, are *responses*. Responses either acknowledge a command issued by the host computer, or reply to a request sent by the host computer.

### **Message Syntax**

The RS-232 message syntax uses the following conventions:

---

**Note**  Spaces and commas are included in the syntax for clarity only. Do not include spaces or commas in actual commands, unless specifically noted.

---

bold	Messages that you must enter exactly as shown in the manual. Do not include any spaces or commas in the message string, unless specifically noted.
italics	Placeholder that represents text or numeric values that you must supply.
response	Format of message sent from the mass flow controller.
;	Represents the end-of-line delimiter or termination character (specified in your communications software). All messages must use a semicolon (;) as the termination character.

## Commands and Requests

Every message sent *from a remote computer* to the mass flow controller must include the following information:

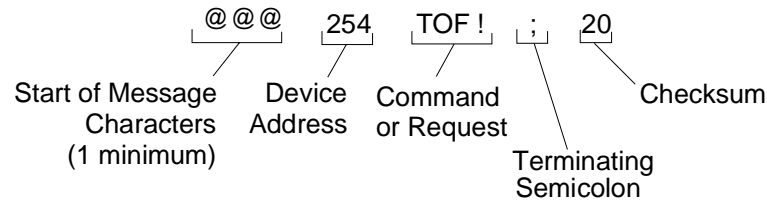

Figure 14: Example Command Message

Start of Message  
Character “@”:

At least 1 start of message character is required for the unit to recognize that a message is being sent. Typically, 1 to 3 start of message characters are used.

Device Address:

A 3 digit device address (001, 002, and so forth through 253) that identifies the individual unit.

Command/Request:

A series of three characters that identify the function.

*Commands* instruct the instrument to change an operating parameter. The command string is followed by an exclamation mark “!” and a data variable field (if relevant).

*Requests* prompt the instrument to report information. The command string is followed by a question mark “?” and a data variable field (if relevant).

Terminating  
Semicolon “;”:

Represents the end-of-line delimiter or termination character.

Command or  
Request Checksum:

The sum of the ASCII values of the characters in the message from the *last* start of message character, up to and including the terminating semicolon, truncated to a hexadecimal integer (two characters). Refer to Figure 15, page 45, for an example of how the checksum is calculated.

### *How To Calculate the Command or Request Checksum*

The checksum in a command or request message is calculated from the sum of the ASCII values of the characters in the message from the *last* start of message character “@”, up to and including the terminating semicolon (refer to Figure 15), using a standard ASCII value chart (refer to Table 17, page 101).

The checksum is the decimal sum of the ASCII values, converted to a hexadecimal value and truncated to its last 2 characters.

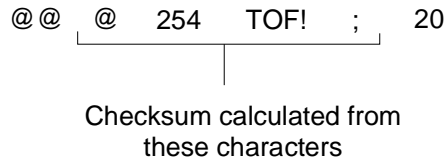

Figure 15: ASCII Characters in a Command Message Used to Calculate the Checksum

For example, the checksum value of “20” shown in Figure 15 was calculated as follows:

CHARACTER	ASCII CODE (decimal)
@	64
2	50
5	53
4	52
T	84
O	79
F	70
!	33
;	59
	Sum = 544 (decimal)
	= 220 (hexadecimal)

**Checksum Value = 20\***

\* hexadecimal sum truncated to the last 2 characters

#### **Note**



1. You must include a checksum value with every command and request message sent to the mass flow controller. The acceptable checksum values range from 00 to FF.
2. You can instruct the software to ignore the checksum by using the checksum value “FF” in every message.

***How To Send a Command***

A command message string consists of at least one start of message character “@”, followed by the device address, a series of three characters “FNC” that identify the function, an exclamation mark “!” to identify the string as a command, a data variable field (if relevant), the terminating semicolon “;”, and the checksum.

**@@@001FNC!data variable;Checksum**

***How To Send a Request***

A request message string consists of at least one start of message character “@”, followed by the device address, a series of three characters “FNC” that identify the function, a question mark “?” to identify the string as a request, a data variable field (if relevant), the terminating semicolon “;”, and the checksum.

**@@@001FNC?data variable;Checksum**



## Responses

Every message sent *from the mass flow controller* to a remote computer includes the following information:

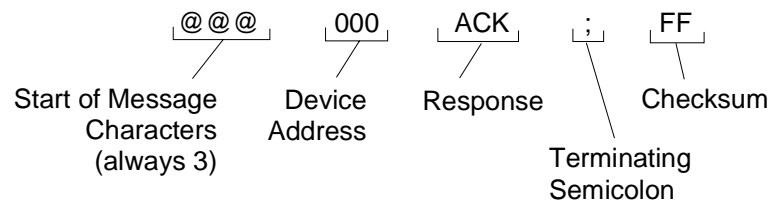

Figure 16: Example Response Message

Start of Message Character “@”:	Three (3) start of message characters are always sent from the controller.
Device Address:	The 3 digit address of the master device (always “000”).
Response:	A literal “ACK” (acknowledged) or “NAK” (not acknowledged) with a data variable field (if relevant). The response either acknowledges a command issued by the host computer, or replies to a request sent by the host computer.
Terminating Semicolon “;”:	Represents the end-of-line delimiter or termination character.
Response Checksum:	The 1153 unit does not calculate a checksum for its response strings. In the response message, the unit <i>always</i> returns a checksum value of “FF.”

If a command or request is accepted and implemented, the response is the three start of message characters “@@@”, followed by the address of the master device (always “000”), a literal “ACK” with a data variable field (if relevant), the terminating semicolon, and the checksum value of “FF.”

**@@@000ACKdata variable;FF**

If a command or request is either invalid or contained an error, the response is the three start of message characters “@@@”, followed by the address of the master device (always “000”), a literal “NAK” with an error code, the terminating semicolon, and the checksum value of “FF.” The error codes are listed in Table 8.

**@@@000NAKerror code;FF**

<b>RS-232 Error Codes</b>	
<b>Error Code</b>	<b>Description</b>
01	Checksum error
10	Syntax error
11	Data length error
12	Invalid data
13	Invalid operating mode
17	Invalid command

Table 8: RS-232 Error Codes

## Required Data Format

The 1153 system software is optimized to utilize integer math; decimals are not accepted in the command strings. Since the actual values of many of the operating parameters are not integers, multiples of 10 are used to accommodate the software format.

### Note



---

The assigned multiple is clearly stated in both the command summary at the start of each message section, as well as in the description of affected commands.

---

For example; the value of the ratio of specific heats,  $K$ , used in the calculation of the system flow, ranges from 1.05 to 2. Since the software cannot accept numbers in a decimal format, it uses a multiple of “100” to calculate the value of the  $K$  constant. Therefore, the desired value must be multiplied by 100 before it is entered in the command string. Likewise, the number reported from a query must be divided by 100 for the true value.

The command string for the  $K$  constant is “ $K \_ \_$ ”; refer to *How To Set the “K” Constant Value*, page 55, for more information.

In this example, the software uses a multiple of “100” to calculate the value of the “ $K$ ” constant.

- The actual range is 1.05 to 2.
- The acceptable input range is 105 to 200.

To report the value of “ $K$ ”, enter:

```
@@@254K _ ?;FF
```

An example response, if the value is 1.67 for Hg, is:

```
@@@000ACK167;FF
```

To change the value of “ $K$ ” for  $N_2$  to 1.39, enter:

```
@@@254K _ !139;FF
```

### Note



---

The data used in this example command is based on the control parameters created for a fictitious 1153 unit, described in *Calibration Parameters*, page 35.

---

## Setup Messages

The Setup messages enable you to configure the 1153 unit for operation by allowing you to review and adjust various operating parameters. These messages can be sent as either commands or queries, except where noted. Refer to *Required Data Format*, page 49, for information on using the proper command string format.

### Note



1. A device address of “254” and a checksum value of “FF” are used in the example messages shown in this section.
2. Commas are included in the syntax for clarity only. Do not include commas in actual commands, unless specifically noted.

RS-232 Setup Messages			
Command	Description	Multiple	Data Variables / Response
CC_	Baud Rate	None	Enter 1,200; 2,400; 4,800; 9,600. Initial setting is 9,600.
CSF	Comm State Flag	None	Enter ANALOG or DIGITAL. Initial setting is ANALOG.
FSR	Full Scale Range - Flow	10	Enter 1 to 4,000,000. Actual range is 0.1 to 400,000 sccm. Initial value is application dependent.
FST	Full Scale Range - Temperature	None	Enter 100 to 500. Initial value in ° C / 5 V is application dependent.
MXT	Maximum Temperature	None	Enter 0 to 210. Initial setting in ° C is application dependent.
K_ _	K Constant	100	Enter 105 to 200. Actual range is 1.05 to 2. Initial value is 1.1.
EV_	Valve Control Parameter E “Phase Lead”	100	Enter -32,000 to 32,000. Actual range is -320 to 320 seconds. Initial value is application dependent.

Table 9: RS-232 Setup Messages  
(Continued on next page)

<b>RS-232 Setup Messages (Continued)</b>			
<b>Command</b>	<b>Description</b>	<b>Multiple</b>	<b>Data Variables / Response</b>
GV_	Valve Control Parameter G “Gain”	100	Enter 1 to 32,000. Actual range is 0.01 to 320. Initial value is application dependent.
CVM	Minimum Valve Conductance (Cv)	100,000	Enter 1 to 500,000. Actual range is 0.00001 to 5 liter/sec (l/s). Initial value is application dependent.
CVX	Maximum Valve Conductance (Cv)	100,000	Enter 1 to 500,000. Actual range is 0.00001 to 5 liter/sec (l/s). Initial value is application dependent.
CIM	Minimum Valve Current	100	Enter 0 to 15,000. Actual range is 0 to 150 mA. Initial setting is application dependent.
CIX	Maximum Valve Current	100	Enter 0 to 15,000. Actual range is 0 to 150 mA. Initial setting is application dependent.
MM_	Molecular Weight	10	Enter 1 to 10,000. Actual range is 0.1 to 1,000 grams per mole (g/mol). Initial value is application dependent.
FTR	Full Scale Flow Range of the Calibration Constant Table	10	Enter 1 to 4,000,000. Actual range is 0.1 to 400,000 sccm. Initial value is application dependent.
FCP	Calibration Constant Table	j = None Value = 1,000	Enter “j, value”, where: j = 0 to 10 value = 1 to 2,000 Actual range is 0.001 to 2
SUD	Save Current Data into EEPROM	None	None
RFD	Reset the Variables from the Factory Defaults	None	None

Table 9: RS-232 Setup Messages

## How To Change the Baud Rate

This command sets the baud rate of the communications protocol. The baud rate changes after this command is complete and the response message is sent. The baud rate can be set to 1,200; 2,400; 4,800; or 9,600 (initial).

### Note



You must change the baud rate at both the instrument and the host computer.

To check the baud rate, enter:

```
@@@254CC_?;FF
```

An example response is:

```
@@@000ACK9600;FF
```

To change the baud rate to 4,800, enter:

```
@@@254CC_!4800;FF
```

## How To Set the Comm State Flag

The communication state flag defines the type of control to be used with your unit. The 1153 instrument can be operated using analog control (initial) through the 15-pin Interface connector, or digital control through the 9-pin RS-232 Serial Interface connector.

### Note



1. The 1153 unit always defaults to analog control, regardless of the state of the comm state flag, when it is powered up.
2. Analog voltages (0 to 5 V) are always sent to the analog output port.

To query the status of the comm state flag, enter:

```
@@@254CSF?;FF
```

An example response is:

```
@@@000ACKANALOG;FF
```

To change to digital control, enter:

```
@@@254CSF!DIGITAL;FF
```

## How To Set the Full Scale Flow Range

This function sets the volume of flow in standard cubic centimeters per minute (sccm) which corresponds to the full scale analog signal (5 V).

### Note



The software uses a multiple of “10” to calculate the value of the full scale flow range.

- The *actual* full scale flow range is 0.1 to 400,000 sccm; the initial value is application dependent.
- The acceptable *input* range is 1 to 4,000,000.

To query the full scale flow range, enter:

```
@@@254FSR?;FF
```

An example response, if the flow rate for the user gas Hg is 50.0 sccm, is:

```
@@@000ACK500;FF
```

To change the full scale flow range for the N<sub>2</sub> calibration gas to 125 sccm, enter:

```
@@@254FSR!1250;FF
```

## How To Set the Full Scale Temperature Range

This function sets the full scale temperature range in degrees Celsius (° C) which corresponds to the full scale analog signal (5 V). The factory set scale factor is 1 V = 100° C. The acceptable temperature input range is 100° to 500° C / 5 V; the initial value is set so that 5 V = 500° C.

The initial value is set so that the voltage of the set point and the output give a direct reading of temperature. Therefore, in the example application described in *Calibration Parameters*, page 35, 2.00 V = 200° C. The maximum temperature of the unit is 200° C.

To query the full scale temperature range, enter:

```
@@@254FST?;FF
```

An example response, if the temperature range is 500° C / 5 V, is:

```
@@@000ACK500;FF
```

To change the full scale temperature range to 200° C / 5 V, enter:

```
@@@254FST!200;FF
```

## How To Set the Maximum Temperature

As a safety feature, the 1153 unit has a “Maximum Temperature” parameter, which sets the maximum temperature, in degrees Celsius ( $^{\circ}$  C) within the 1153 enclosure.

If the temperature within the unit rises above the maximum temperature, the temperature controller immediately turns off the power to the heaters and the internal status LED flashes RED. The LED will continue to flash RED, even after if the error is corrected, until the power to the unit is cycled off and on. The power to the heaters can be restored by issuing the “TON” command (refer to *How To Turn the Temperature Controller ON*, page 66).

This feature is useful for vapors known to decompose above some temperature. Because the temperature controller may have some overshoot when first approaching the temperature set point, the maximum temperature parameter should be set at least  $5^{\circ}$  C above the set point (refer to *How To Set the Temperature Set Point*, page 65).

The acceptable range is  $0^{\circ}$  to  $210^{\circ}$  C. The initial setting is application dependent; a typical value is  $205^{\circ}$  C.

To report the maximum temperature setting, enter:

```
@@@254MXT?;FF
```

An example response is:

```
@@@000ACK205;FF
```

To change the temperature to  $180^{\circ}$  C, enter:

```
@@@254MXT!180;FF
```



## How To Set the “K” Constant Value

This function sets the value of the “K” constant, used in the flow calculation. This constant is gas dependent and represents the ratio of specific heats of the flowing gas.

---

**Note**

The software uses a multiple of “100” to calculate the value of the “K” constant.

- The *actual* range is 1.05 to 2; the initial setting is application dependent.
  - The acceptable *input* range is 105 to 200.
- 

To report the value of “K”, enter:

```
@@@254K __?;FF
```

An example response, if the value is 1.67 for Hg, is:

```
@@@000ACK167;FF
```

To change the value of “K” for N<sub>2</sub> to 1.39, enter:

```
@@@254K __!139;FF
```

## How To Set the Valve Control Parameters

These functions set the value of the valve control parameters E and G, used in the flow control calculations. These constants are described in detail in *Proportional - Integral (PI) Control Theory*, page 29.

### How To Set the Valve Control Parameter E (Phase Lead)

The valve control parameter E or *phase lead*, is set using the “EV\_” command.

#### Note



The software uses a multiple of “100” to calculate the value of “EV\_.”

- The *actual* range is -320 to 320 seconds; the initial setting is optimized at the factory.
- The acceptable *input* range is -32,000 to 32,000.

To report the value of “EV\_”, enter:

```
@@@254EV_?;FF
```

An example response, if the value is 0.13 for Hg, is:

```
@@@000ACK13 ; FF
```

To change the value of the “EV\_” constant for N<sub>2</sub> to 0.01, enter:

```
@@@254EV_!1;FF
```

### How To Set the Valve Control Parameter G (Gain)

The valve control parameter G, or *gain*, is set using the “GV\_” command.

#### Note



The software uses a multiple of “100” to calculate the value of “GV\_.”

- The *actual* range is 0.01 to 320; the initial setting is optimized at the factory.
- The acceptable *input* range is 1 to 32,000.

To report the value of “GV\_”, enter:

```
@@@254GV_?;FF
```

An example response, if the value is 1.67 for Hg, is:

```
@@@000ACK167 ; FF
```

To change the value of the “GV\_” constant for N<sub>2</sub> to 0.67, enter:

```
@@@254GV_!67;FF
```

## How To Set the Valve Conductance Levels

These functions set the minimum and maximum valve conductance levels, in liters per second (l/s), used in the flow calculation. These constants are described in detail in *Proportional - Integral (PI) Control Theory*, page 29.

### Note



The software uses a multiple of 100,000 to calculate the conductance values.

- The *actual* range is 0.00001 to 5 l/s; the initial value is application dependent.
- The acceptable *input* range is 1 to 500,000.

### *How To Set the Minimum Valve Conductance*

To query the minimum valve conductance value, enter:

**@@@254CVM?;FF**

An example response, if the minimum valve conductance rate is 0.0042 l/s, is:

@@@000ACK420 ; FF

To change the minimum valve conductance rate to 0.0105 l/s, enter:

**@@@254CVM!1050;FF**

### *How To Set the Maximum Valve Conductance*

To query the maximum valve conductance value, enter:

**@@@254CVX?;FF**

An example response, if the maximum valve conductance rate is 0.42 l/s, is:

@@@000ACK42000 ; FF

To change the maximum valve conductance rate to 1.05 l/s, enter:

**@@@254CVX!105000;FF**

## How To Set the Valve Current Levels

These functions set the minimum and maximum valve current values. These constants are described in detail in *Proportional - Integral (PI) Control Theory*, page 29.

### Note



---

The valve current values are optimized at the factory and should not be adjusted without consulting MKS Instruments.

---

### Note



---

The software uses a multiple of “100” to calculate the valve current values.

- The *actual* range is 0 to 150 milliamperes (mA); the initial value is application dependent.
  - The acceptable *input* range is 0 to 15,000.
- 

### *How To Set the Minimum Valve Current*

To query the value of the minimum valve current, enter:

**@@@254CIM?;FF**

An example response, if the minimum current value is 68 mA, is:

@@@000ACK6800;FF

To change the minimum current value to 50 mA, enter:

**@@@254CIM!5000;FF**

### *How To Set the Maximum Valve Current*

To query the value of the maximum valve current, enter:

**@@@254CIX?;FF**

An example response, if the maximum current value is 117 mA, is:

@@@000ACK11700;FF

To change the current value to 100 mA, enter:

**@@@254CIX!10000;FF**

## How To Set the Molecular Weight

This function identifies the molecular weight of the gas being monitored.

### Note



---

The software uses a multiple of “10” to calculate the value of the molecular weight.

- The *actual* range is 0.1 to 1,000 grams per mole (g/mol); the initial value is application dependent.
  - The acceptable *input* range is 1 to 10,000.
- 

To report the molecular weight, enter:

**@@@254MM\_?;FF**

An example response, if the molecular weight for Hg is 200.6 g/mol, is:

@@@000ACK2006;FF

To change the molecular weight to 28 for N<sub>2</sub>, enter:

**@@@254MM\_!280;FF**

## How To Set the Full Range of the Calibration Constant Table

This command sets the full scale flow range of the Calibration Constant Table.

This function allows you to change the full scale flow range of the unit (set with the “FSR” command, refer to *How To Set the Full Scale Flow Range*, page 53) without having to update the entire Calibration Constant Table for the new range.

### Note



---

The software uses a multiple of “10” to calculate the value of the full scale flow of the Calibration Table.

- The *actual* full scale flow range is 0.1 to 400,000 sccm; the initial value is application dependent.
  - The acceptable *input* range is 1 to 4,000,000.
- 

To query the full scale range of the calibration table, enter:

**@@@254FTR?;FF**

An example response, if the full scale range of the Hg gas calibration table is 50 sccm, is:

@@@000ACK500 ; FF

To change the full scale range of the N2 gas calibration table to 125 sccm, enter:

**@@@254FTR!1250;FF**

## How To Setup the Calibration Constant Table

The “FCP” command allows you to enter the calibration constants for each of the cardinal set points (10%, 20%, ..., 100% of full scale flow rate). The “FTR” command, defined in *How To Set the Full Range of the Calibration Constant Table*, page 60, is used to enter the full scale flow rate (in sccm) that corresponds to the 100% point in the calibration table.

---

**Note**  The initial values for the calibration constants in this table are determined during flow calibration and are provided on the Calibration Data Sheet supplied with the 1153 unit (refer to Figure 9, page 34).

---

The *query* for this function is formatted as:

**@@@254FCP?j;FF**

The variable “j” specifies the data point being referred to (for example, j = 0 for the 0% point, j = 1 for the 10% point, j = 10 for the 100% point).

The *command* for this function is formatted as:

**@@@254FCP!j,value;FF**

The variable “value” specifies the calibration gas flow for the specified data point “j”, in sccm. *A comma is required between the variable “j” and its value.*

---

**Note**  The software does not use a multiple for the value of “j.”  
A multiple of “1,000” is used to calculate the value of each calibration point.

- The actual and acceptable *input* range for “j”, is 0 to 10.
- The *actual* range for the value is 0.001 to 2, with an initial value of 1.
- The acceptable *input* range for the value is 1 to 2,000.

---

To query the value of the calibration point at the 10% FS flow point for Hg, enter:

**@@@254FCP?1;FF**

An example response, if the value of the 10% FS flow point for Hg is 0.585, is:

**@@@000ACK1,585;FF**

To change the value of the calibration point at the 10% FS flow point for N<sub>2</sub> to 0.524, enter:

**@@@254FCP!1,524;FF**

### How To Save Data to the EEPROM

When parameters are changed using RS-232 commands (such as changing the molecular weight or changing the valve control parameters), they are stored in the 1153 unit's temporary memory (RAM). *If the unit is powered down, the changes are not saved.*

The "SUD" command stores the current settings in permanent memory (EEPROM), so that they are saved upon power down. There is no query associated with this function.

---

**Note**

The flow and temperature set points must always be reset after the instrument is powered up. Refer to *How To Set the Flow Set Point*, page 64, and *How To Set the Temperature Set Point*, page 65, for more information.

---

To save the current data to the EEPROM, enter:

**@@@254SUD!;FF**

### How To Reset the Factory Settings

This command resets all of the user-set parameters to the initial, factory settings. There is no query associated with this function.

To reset the parameters, enter:

**@@@254RFD!;FF**



## Control Messages

Use the Control messages to set the flow and temperature set points, and to control the temperature controller and valve position. These messages can be sent as either commands or queries, except where noted. Refer to *Required Data Format*, page 49, for information on using the proper command string format.

### Note



1. A device address of “254” and a checksum value of “FF” are used in the example messages shown in this section.
2. Commas are included in the syntax for clarity only. Do not include commas in actual commands, unless specifically noted.

RS-232 Control Messages			
Command	Description	Multiple	Data Variables / Response
FSP	Flow Set Point	1,000	Enter 0 to 400,000,000. Actual range is 0 to 400,000; no initial setting.
TSP	Temperature Set Point	100	Enter 0 to (Max Temp x 100). Actual range is 0 to Max Temp; no initial setting.
TOF	Temperature Controller OFF	None	None
TON	Temperature Controller ON	None	None
OPV	Open Valve	None	None
CLV	Close Valve	None	None
CTV	Control Valve	None	None

Table 10: RS-232 Control Messages

## How To Set the Flow Set Point

The “FSP” command sets the flow set point in sccm. Note that when operating in the analog mode, the flow set point is taken from the 0 to 5 V input signal, measured from pin 8 on the Interface connector. Refer to Table 3, page 20, for the Interface connector pinout. For more information on the analog control of the flow set point, refer to *How To Set the Flow Set Point*, page 40.

---

**Note**

The software uses a multiple of “1,000” to calculate the value of the flow set point.

- The *actual* range is 0 to 400,000 sccm.
  - The acceptable *input* range is 0 to 400,000,000.
- 

To query the flow set point, enter:

```
@@@254FSP?;FF
```

An example response, if the set point is 50 sccm, is:

```
@@@000ACK50000;FF
```

To change the set point to 25 sccm, enter:

```
@@@254FSP!25000;FF
```

## How To Set the Temperature Set Point

The “TSP” command sets the temperature set point. Note that when operating in the analog mode, the temperature set point is taken from the 0 to 5 V input signal, measured from pin 10 on the Interface connector. Refer to Table 3, page 20, for the Interface connector pinout. For more information on the analog control of the temperature set point, refer to *How To Set the Temperature Set Point*, page 39.

---

**Note**

The software uses a multiple of “100” to calculate the value of the temperature set point.

- The *actual* range is 0 to Maximum Temperature (MXT).
- The acceptable *input* range is 0 to (Maximum Temperature x 100).

Refer to *How To Set the Maximum Temperature*, page 54, for information on setting the maximum temperature within the 1153 enclosure.

---

To query the temperature set point, enter:

```
@@@254TSP?;FF
```

An example response, if the set point is 200° C, is:

```
@@@000ACK20000;FF
```

To change the set point to 190° C, enter:

```
@@@254TSP!19000;FF
```

### How To Turn the Temperature Controller OFF

By default, the temperature controller is ON. The CPU compares the actual unit temperature to the set point and adjusts the power to the heaters as required. The “TOF” command turns the temperature controller off, and shuts off power to the heater. There is no query associated with this function.

To turn the controller *off*, enter:

**@@@254TOF!;FF**

### How To Turn the Temperature Controller ON

The “TON” command turns the temperature controller ON and allows power to return to the heaters, after having been manually turned off with the “TOF” command, or automatically turned off because the temperature within the 1153 enclosure rose above the maximum temperature (refer to *How To Set the Maximum Temperature*, page 54, for more information). There is no query associated with this function.

To turn the controller *on*, enter:

**@@@254TON!;FF**

---

**Note**

If the power to the heaters was shut off because the temperature rose above the maximum temperature, the status LED will continue to flash RED, even after if the error is corrected, until the power to the unit is cycled off and on.

---

## How To Control the Operation of the Valve

These commands control the operation of the valve inside of the 1153 unit. There are no queries associated with these functions. To query the type of valve operation, use the “VSF” command, as described in *How To Report the Type of Valve Operation*, page 74.

### *How To Open the Valve*

The “OPV” command causes the maximum valve current, set with the “CIX” command (refer to *How To Set the Maximum Valve Current*, page 58), to be sent to the valve.

To open the valve, enter:

**@@@254OPV!;FF**

### **Note**



---

The maximum valve current restriction can be overridden in the valve open mode by using the “SIV” command (refer to *How To Set the Valve Current*, page 92). This may be useful when purging the system and not attempting to control flow.

---

### *How To Close the Valve*

The “CLV” command causes zero current to be sent to the valve.

To close the valve, enter:

**@@@254CLV!;FF**

### *How To Set the Valve to Control to the Flow Set Point*

The “CTV” command instructs the CPU to control the valve position based on the flow set point (refer to *How To Set the Flow Set Point*, page 64).

To set the valve to flow control mode, enter:

**@@@254CTV!;FF**

## Informational Messages

The Informational messages report data on the 1153 system, including system flow, temperature, and pressure. These messages, with the exception of the status reset command, can only be sent as queries. Refer to *Required Data Format*, page 49, for information on using the proper command string format.

### Note



1. A device address of “254” and a checksum value of “FF” are used in the example messages shown in this section.
2. Commas are included in the syntax for clarity only. Do not include commas in actual commands, unless specifically noted.

RS-232 Informational Messages			
Command	Description	Multiple	Response
T__	System Status	None	Indicates the state of the system. Refer to Table 12, page 70.
SR_	Status Reset	None	Clears the reset bit in the system status byte.
VER	Software Version	None	Reports the software version number.
CF_	Flow	1,000	Reports the current gas flow through the unit in scfm. Reported and actual flow values are application dependent.
CT_	Temperature	100	Reports the current temperature in the unit in degrees Celsius (° C). Reported range is 0 to 20,000. Actual range is 0 to 200° C.
RPA	Pressure of Upstream Baratron (P1)	1,000	Reports the pressure in Torr. Reported and actual pressure ranges are application dependent.
RPB	Pressure of Downstream Baratron (P2)	1,000	Reports the pressure in Torr. Reported and actual pressure ranges are application dependent.
VSF	Valve State	None	Reports the position of the valve as OPEN, CLOSED, or CONTROL.

Table 11: RS-232 Informational Messages  
(Continued on next page)

<b>RS-232 Informational Messages (Continued)</b>			
<b>Command</b>	<b>Description</b>	<b>Multiple</b>	<b>Response</b>
RP_	Required Power	100	Reports the power required for the heater to maintain or reach the set point. Reported range is 0 to 20,000. Actual range is 0 to 200 Watts.
FCA	Discharge Coefficient	1,000	Reports the value of the discharge coefficient being used in the current flow calculations. Reported range is 1 to 2,000. Actual range is 0.001 to 2.
VRF	V reference	10,000	Reports the system voltage. When the system is operating properly, this value should be close to 5 Volts.

Table 11: RS-232 Informational Messages

### How To Report the System Status

The System Status command “T \_ \_” reports the value of the system status byte which contains information on the status of the 1153 system. The assignments and values for each bit are listed in Table 12.

The reported value is the sum of the individual status bit values that are set. Each bit is initially set *low* (value = 0), meaning the error condition does not exist. When an error condition is detected, the appropriate bit is set *high* (to the bit value listed in Table 12).

System Status Byte			
Bit	Assignment	Description	Bit Value
0	Reset	Indicates whether system has been reset.	1
1	Analog I/O Cable Connect	Bit is set <i>high</i> if the cable is not connected.	2
2	Unused	Bit is always set low.	4
3	EEPROM	Bit is set <i>high</i> if there is any type of EEPROM error either in reading data from or writing data to the EEPROM.	8
4	RAM	Bit is set <i>high</i> if there is any error in the RAM.	16
5	ROM	Bit is set <i>high</i> if there is an error in the ROM checksum. Checked during initialization.	32
6	Unused	Bit is always set low.	64
7	Temperature	Bit is set <i>high</i> if the indicated 1153 temperature exceeds the MAX TEMP; the processor shuts off power to the heaters.	128

Table 12: System Status Byte



To query the system status, enter:

```
@@@254T_?;FF
```

An example response, if no error conditions exist, is:

```
@@@000ACK0;FF
```

An example response, if there is an error in the EEPROM, is:

```
@@@000ACK8;FF
```

An example response, if there are errors in both the EEPROM and the temperature control system, is:

```
@@@000ACK136;FF
```

The status byte value of 136 represents the sum of the individual status bit values for the EEPROM (8) and temperature (128) control.

### How To Clear the Reset Bit

The Status Reset command clears the reset bit in the system status byte. There is no query associated with this function.

#### Note



1. The reset bit is the only bit in the status byte that can be reset using a software command. All other error conditions (refer to Table 12, page 70) must be corrected before the corresponding bit will be cleared.
2. If you clear the reset bit after first powering up the unit, the reset bit can then be monitored to see if power to the unit is later interrupted.

To send the status reset command, enter:

```
@@@254SR!;FF
```

If an error occurs after the status flags are cleared, the flags are immediately reset.

### How To Report the Software Version

This query reports the version of software in your unit. There is no command associated with this function.

To check the software version, enter:

```
@@@254VER?;FF
```

An example response is:

```
@@@000ACKV1.00;FF
```

## How To Report the Gas Flow

This query reports the current gas flow through your unit in sccm. There is no command associated with this function.

### Note



---

The software uses a multiple of “1,000” to calculate the flow.

- The *actual* and *reported* flow ranges are application dependent.
- 

To report the flow, enter:

```
@@@254CF_?;FF
```

An example response, if the flow is 50 sccm, is:

```
@@@000ACK50000;FF
```

## How To Report the Temperature

This query reports the current temperature in degrees Celsius (° C) of the heated components (such as the valve and flow bodies) in the 1153 unit. There is no command associated with this function.

### Note



---

The software uses a multiple of “100” to calculate the temperature in ° C.

- The *actual* temperature range is 0 to 200° C.
  - The *reported* range is 0 to 20,000.
- 

To report the temperature, enter:

```
@@@254CT_?;FF
```

An example response, if the temperature is 150° C, is:

```
@@@000ACK15000;FF
```

## How To Report the Pressure

These queries report the current pressure in Torr, measured by the Baratrons inside of the 1153 unit. There are no commands associated with these functions.

### Note



---

The software uses a multiple of “1,000” to calculate the pressure values from the two transducers, in Torr.

- The *actual* and *reported* pressure ranges are application dependent.
- 

### *How To Report the Pressure of the Upstream Baratron (P1)*

To report the pressure of the upstream Baratron, enter:

```
@@@254RPA?;FF
```

An example response, if the pressure is 6.45 Torr, is:

```
@@@000ACK6450;FF
```

### *How To Report the Pressure of the Downstream Baratron (P2)*

To report the pressure of the downstream Baratron, enter:

```
@@@254RPB?;FF
```

An example response, if the pressure is 2.004 Torr, is:

```
@@@000ACK2004;FF
```

### How To Report the Type of Valve Operation

This query reports the state of the valve as open, closed (initial), or control. There is no command associated with this function. The valve position is set using the “OPV”, “CLV”, and “CTV” commands, as described in *How To Control the Operation of the Valve*, page 67.

To query the position of the valve, enter:

```
@@@254VSF?;FF
```

An example response, is:

```
@@@000ACKCLOSED;FF
```

### How To Report the Power Required by the Heaters

This query reports the power required by the heaters to maintain or reach the desired temperature set point. There is no command associated with this function.

#### Note



---

The software uses a multiple of “100” to calculate the power value.

- The *actual* power range is 0 to 200 Watts.
  - The *reported* range is 0 to 20,000.
- 

To report the power, enter:

```
@@@254RP_?;FF
```

An example response, if the required power is 200 Watts, is:

```
@@@000ACK200000;FF
```

### How To Report the Discharge Coefficient

This query reports the current discharge coefficient being used in the flow calculations. There is no command associated with this function.

**Note**

---

The software uses a multiple of “1,000” to calculate the current discharge coefficient.

- The *actual* range is 0.001 to 2.
  - The *reported* range is 1 to 2.000.
- 

To report the value of the discharge coefficient, enter:

**@@@254FCA?;FF**

An example response, if the discharge coefficient is 0.85, is:

@@@000ACK850;FF

### How To Report the System Reference Voltage

This query reports the current system voltage ( $V_{ref}$ ) level, from 0 to 5 V. There is no command associated with this function.

**Note**

---

The software uses a multiple of “10,000” to calculate the system voltage. When the system is functioning properly, the voltage should be approximately 5 Volts.

---

To report the value of  $V_{ref}$ , enter:

**@@@254VRF?;FF**

An example response, if the system reference voltage is 4.9973 Volts, is:

@@@000ACK49973;FF

This page intentionally left blank.

## Chapter Six: Maintenance and Troubleshooting

### General Information

If the 1153 system fails to operate properly upon receipt, check for shipping damage, and check the cables for proper continuity. Any damage should be reported to the carrier and MKS Instruments immediately. If it is necessary to return the unit to MKS, obtain an ERA number (Equipment Return Authorization Number) from a MKS Service Center before shipping. Please refer to the inside back cover of this manual for a list of MKS Calibration and Service Centers.

---

**Warning**

**All returns to MKS Instruments must be free of harmful, corrosive, radioactive, or toxic materials.**

---

### Maintenance

Periodically check for wear on the cables and inspect the enclosure for visible signs of damage. Otherwise, no maintenance is required on the instrument for normal use.

If you are using the 1153 unit in a harsh environment, refer to *System Checks*, page 78, for information on checking the unit's performance and seal integrity.

Refer to *How To Adjust the Transducer Zero*, page 79, for instructions on correcting any small zero shifts in the two Baratron transducers.

## System Checks

When using the 1153 unit in a harsh environment, use the following system checks to determine if any compromise in performance or seal integrity has occurred. If a problem is detected, contact MKS for assistance. Prior to any return, the instrument must be purged of all contaminants.

### Warning



---

**Read and follow all safety messages listed in *Safety Procedures and Precautions*, page 3, BEFORE attempting to service the 1153 unit. Failure to adhere to these messages could result in injury to personnel.**

---

1. Pump any condensable material out of the instrument.
2. Purge the instrument thoroughly at operating temperature with a dry purge gas.
3. Check the calibration of the 1153.  
Refer to *Calibration*, page 33, and *How To Setup the Calibration Constant Table*, page 61, for more information.
4. Check the flow of the calibration gas.  
Refer to *How To Report the Gas Flow*, page 72.
5. Check the control response and stability of the instrument.



## How To Adjust the Transducer Zero

The two Baratron transducers inside the 1153 unit are calibrated at the factory. However, the zero adjustment pots, located on the rear panel of the unit (refer to Figure 6, page 18), may need to be adjusted to correct for any small zero shifts which can occur over time or due to ambient temperature changes.

---

**Note**  Ensure that the 1153 MFC is warmed up for a minimum of 4 hours before adjusting the zero potentiometer.

---

1. Pump down the unit to a pressure below the gauge resolution.
2. Use an insulated screwdriver to set the ZERO potentiometer for an output of zero volts (display reads “0000”).

Refer to Table 13 for the highest suggested base pressures for proper zero adjustment.

Highest Base Pressures for Zero Adjustment	
Full Scale Range (Torr)	Highest Base Pressure for Proper Zero Adjust (Torr)
10	$1 \times 10^{-3}$
100	$1 \times 10^{-2}$
1000	$1 \times 10^{-1}$
5000	$5 \times 10^{-1}$

Table 13: Highest Base Pressures for Zero Adjustment

All capacitance manometers require that initial and periodic zero adjustments be made at a pressure lower than their minimum resolution in order to ensure that the full dynamic range specified can be achieved. Zeroing a transducer at some pressure above its stated minimum resolution will create a “zero offset” relative (or unique) to the system on which the transducer is located. All readings made subsequent to the offset will be linear and accurate relative to the offset zero value.

If available pressures are not sufficiently low to set the transducer zero, a vacuum leak detector may be used. In this case, mount the transducer on the leak detector *in the same plane of orientation as where it will be used*.

---

**Note**  The transducers are calibrated to your specifications at the factory and every effort is made to ensure that shipments arrive at your location free of defects or need for further calibration other than zero adjustment. ***MKS recommends that you do not attempt adjustments other than zero.***

---

## Troubleshooting

### Electrostatic Discharge

If an electrostatic discharge (ESD) occurs near the 1153 unit, it may reset itself to the Analog mode. Refer to *Start Up*, page 23, for instructions on how to reset the communications state.

### Troubleshooting Chart

**Note**



The 1153 unit is optimized at the factory for specified application parameters. Contact MKS if an application change is desired.

<b>Troubleshooting Chart</b>		
<b>Symptom</b>	<b>Possible Cause</b>	<b>Remedy</b>
No output	Pressure in system is too high Improper cable Valve not opening Electronics	Check system pressure Check cable for type and damage Return to MKS for service Return to MKS for service
Controller does not maintain set point	Improper zero adjustment Unstable process system pressure Insufficient delivery pressure	Zero the output of the Baratrons (refer to <i>How To Adjust the Transducer Zero</i> , page 79) Stabilize system process pressure control loop Raise temperature of source material
Controller does not function	Condensation Valve override function applied Electronics	Check line temperatures, evacuate overnight Disconnect valve override function Return to MKS for service
Unit produces large pressure drop or will not pass full flow	Clogged orifice and/or valve	Purge the unit with a dry, inert gas

Table 14: Troubleshooting Chart  
(Continued on next page)

<b>Troubleshooting Chart (Continued)</b>		
Symptom	Possible Cause	Remedy
Oscillation	<p>Condensation of vapors in the 1153 unit, or in the up- or downstream plumbing</p> <p>Downstream pressure control may fight the flow controller, caused by improperly set gain and phase lead of the pressure loop</p> <p>Incorrect controller parameter settings may cause instability of flow</p>	<p>Ensure the source feed lines are setup properly (refer to <i>Source Feed Line Temperature</i>, page 14)</p> <p>Restabilize the pressure loop with the flow on (refer to <i>How To Set the Valve Control Parameters</i>, page 56)</p> <p>These settings are set correctly at the factory, but because of different system configurations, a change may be necessary. Review the control parameters for your application; contact the MKS Applications Department for assistance if necessary.</p>
Unit is non-linear, has erratic flow, or unable to zero MFC	<p>Condensation</p> <p>Electronics</p> <p>Improper Cable</p> <p>System pressure too high</p> <p>Limited downstream conductance</p> <p>Oscillation</p>	<p>Check line temperatures, evacuate overnight</p> <p>Return to MKS for service</p> <p>Check cable for type and damage</p> <p>Check that system pressure is the same as shown on Calibration Data Sheet</p> <p>Reconfigure downstream plumbing (shorten length or increase inside diameter)</p> <p>Ensure the source feed lines are setup properly (refer to <i>Source Feed Line Temperature</i>, page 14)</p> <p>Adjust the valve gain parameter (refer to <i>How To Set the Valve Control Parameter G (Gain)</i>, page 56)</p>

Table 14: Troubleshooting Chart

This page intentionally left blank.

## Appendix A: Product Specifications

Accuracy <sup>1</sup>	±3.0% of Full Scale (FS)
Attitude Sensitivity	Do not mount unit upside down
CE Mark Compliance <sup>2</sup>	Consult Factory
Connectors RS-232 (digital operation) Interface (analog operation) DC Power (powers transducers and valve circuitry) AC Power (powers heaters)	9-pin female, digital 15-pin Type “D” female, RFI/EMI shielded 9-pin Type “D” male, RFI/EMI shielded 15-pin Type “D” male, RFI/EMI shielded
Control Range	10 to 100% FS
Dimensions	12.44” L x 5.0” W x 8.51” H (316.0 mm x 127 mm x 216.2 mm)
Fittings	Cajon 8-VCR male
Flow Output Signal	0 to 5 VDC from < 10K ohm source
Full Scale Ranges Pressure Transducer Flow	Dependent on process conditions 10, 20, 100, 1000, 5000 Torr ~ 1 to 50,000 sccm
Input Power Required Heater Transducer and Valve Control Circuitry (Analog Control)	24 VAC @ 8 Amps ±15 VDC ±5% @ 1 Amp
Internal Volume	69 cc
Leak Integrity To atmosphere (internal to external) Through closed valve (closed conductance)	< 1 x 10 <sup>-9</sup> scc/sec He < 3% of FS at process conditions

---

<sup>1</sup>Includes controller error, linearity, hysteresis, and repeatability.

<sup>2</sup>A metal braided shielded cable, properly grounded at both ends, is required during use.

Maximum Inlet Pressure	35 psia or 120% of pressure transducer range (whichever is greater)
Maximum Overshoot	40% of set point
Measurement Resolution	±0.1% of FS
Media Compatibility	Any vapor compatible within 316L SS, Inconel®, Nickel
Operating Temperature Range	
Unit	30° to 200° C (86° to 392° F)
Environment	15° to 45° C (59° to 113° F)
Process Wetted Materials	316L SS, Inconel®, Nickel
Repeatability	±0.2% of Full Scale
RTD Accuracy	±3° C
Sampling Rates	100 millisecond updates for flow 1 to 2 second updates for temperature
Set Point Signal	0 to 5 VDC from < 20K ohm source
Settling Time	2 seconds to within ±2% of set point
Software	
RS-232 operational functions	Flow Temperature Valve OPEN/CLOSED/CONTROL Gas Calibration Factors (ratio of specific heats, molecular weight, calibration constants)
Storage Humidity Range	0 to 95% RH, non-condensable
Storage Temperature Range	-20° to 80° C (-4° to 176° F)
Temperature Coefficients	
Zero	0.02% FS / ° C
Span	0.15% FS / ° C
Temperature Output Signal	0 to 5 VDC (user adjustable)
Transducer Output Signal	0 to 10 V
Warm Up Time	4 hours
Weight	15.5 lb (7.03 kg)

Due to continuing research and development activities, these product specifications are subject to change without notice.

## Appendix B: Model Code Explanation

The model code of your 1153 Mass Flow Controller designates the unit designed for your unique application. The serial number label, shown in Figure 13, page 38, lists the model code for your 1153 instrument.

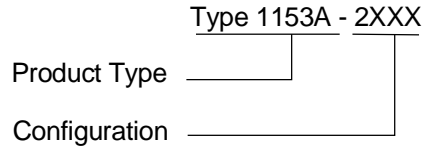

### Product Type

The product type designates the model number of the instrument. The unit is identified as the Type 1153A.

### Configuration

The model code configuration is assigned after the application is designed, as defined by the flow rate, gas, and pressure conditions.

Each configuration is unique to its application, where XXX = 001 to 999.

This page intentionally left blank.



## Appendix C: Application Specific Parameters

### RS-232 Application Specific Messages

The RS-232 Application Specific messages set the device address; the operating parameters for the Baratrons; and the nozzle diameter, valve current, temperature control parameters, and overall calibration constant used in the flow control calculations. These parameters were optimized at MKS for your specific application and *should not be changed without first contacting the MKS Applications Department*. Improper use of these commands will alter operation of your 1153 system. If it is necessary to review or adjust any of these parameters, refer to *Required Data Format*, page 49, for information on using the proper command string format.

#### Note



1. A device address of “254” and a checksum value of “FF” are used in all of the example messages shown in this section.
2. Commas are included in the syntax for clarity only. Do not include commas in actual commands, unless specifically noted.

RS-232 Application Specific Messages			
Command	Description	Multiple	Data Variables / Response
CA_	Change Address	None	Enter 1 to 253. Initial address is 254.
RBA	Full Scale Range - Upstream Baratron (P1)	None	Enter 1 to 10,000. Initial setting, in Torr, is application dependent.
RBB	Full Scale Range - Downstream Baratron (P2)	None	Enter 1 to 10,000. Initial setting, in Torr, is application dependent.
GBA	Gain of Upstream Baratron (P1)	1,000	Enter 1 to 2,000. Actual range is 0.001 to 2. Initial setting is 1.
GBB	Gain of Downstream Baratron (P2)	1,000	Enter 1 to 2,000. Actual range is 0.001 to 2. Initial setting is 1.

Table 15: RS-232 Application Specific Messages  
(Continued on next page)

<b>RS-232 Application Specific Messages (Continued)</b>			
<b>Command</b>	<b>Description</b>	<b>Multiple</b>	<b>Data Variables / Response</b>
OBA	Offset of Upstream Baratron (P1)	1,000	Enter -2,000 to 2,000. Actual range is -2 to 2 Volts. Initial setting is 0 Volt.
OBB	Offset of Downstream Baratron (P2)	1,000	Enter -2,000 to 2,000. Actual range is -2 to 2 Volts. Initial setting is 0 Volt.
ND_	Nozzle Diameter	1,000	Enter 1 to 500. Actual range is 0.001 to 0.25 inches. Initial setting is application dependent.
SIV	Valve Current	100	Reports 0 to 15,000. Actual range is 0 to 150 mA. Initial setting is application dependent.
ET_	Temperature Control Parameter E	None	Factory set value is 900.
GT_	Temperature Control Parameter G	100	Reports 1. Actual factory set value is 0.01.
CON	Calibration Constant	1,000	Enter 1 to 2,000. Actual range is 0.001 to 2. Initial value is 1.

Table 15: RS-232 Application Specific Messages

### How To Change the Address

This command changes the 3 digit address of an individual device. The address change takes effect *after* this command is complete and the response message is sent. The address for an individual unit can range from 001 to 253; the initial address is 254.

To query the address, enter:

**@@@254CA?;FF**

An example response is:

@@@000ACK254 ; FF

To change the address from the initial setting of 254 to 001, enter:

**@@@254CA!001;FF**

### How To Set the Baratron Full Scale Ranges

These functions set the full scale ranges for the two Baratron transducers inside of the 1153 unit. The acceptable input range for each unit is 1 to 10,000 Torr; the initial settings are application dependent.

#### *How To Set the Full Scale Range for the Upstream Baratron (P1)*

To report the full scale range for the upstream Baratron, enter:

**@@@254RBA?;FF**

An example response, for a 100 Torr unit, is:

@@@000ACK100;FF

To change the full scale range to 500 Torr, enter:

**@@@254RBA!500;FF**

#### *How To Set the Full Scale Range for the Downstream Baratron (P2)*

To report the full scale range for the downstream Baratron, enter:

**@@@254RBB?;FF**

An example response, for a 5000 Torr unit is:

@@@000ACK5000;FF

To change the full scale range to 1000 Torr, enter:

**@@@254RBB!1000;FF**

## How To Set the Baratron Gain and Offset Parameters

The pressure transducers are calibrated in the unit during final system calibration, before it is shipped. If a shift occurs over time, it is best to return the unit to MKS to be recalibrated. However, as an interim fix, the transducer output can be modified in the software using the gain and offset parameters. These parameters modify the transducer output voltage using:

$$V_{\text{modified}} = \text{Gain} \times (V_{\text{actual}} - \text{Offset})$$

For zero drift, it is best to use the zero adjustment pots, rather than changing the gain or offset values. Refer to *How To Adjust the Transducer Zero*, page 79, for more information.

### Note



If you choose to change the gain or offset parameter using software commands, the P<sub>1</sub> and P<sub>2</sub> values used in the flow calculations will be different than those from the analog output.

## How To Set the Gain Value for the Baratrons

### Note



The software uses a multiple of “1,000” to calculate the gain values.

- The *actual* range is 0.001 to 2, with an initial value of 1.
- The acceptable *input* range is 1 to 2,000.

## How To Set the Gain for the Upstream Baratron (P1)

To report the gain setting for the upstream Baratron, enter:

```
@@@254GBA?;FF
```

An example response, if the gain setting is 1, is:

```
@@@000ACK1000;FF
```

To change the gain to 1.004, enter:

```
@@@254GBA!1004;FF
```

## How To Set the Gain for the Downstream Baratron (P2)

To report the gain for the downstream Baratron, enter:

```
@@@254GBB?;FF
```

An example response, if the gain setting is 1, is:

```
@@@000ACK1000;FF
```

To change the gain setting to 0.997, enter:

```
@@@254GBB!997;FF
```

*How To Set the Offset Value for the Baratrons***Note**

---

The software uses a multiple of “1,000” to calculate the offset values.

- The *actual* range is -2 to 2 Volts, with an initial value of 0 Volt.
  - The acceptable *input* range is -2,000 to 2,000.
- 

**How To Set the Offset for the Upstream Baratron (P1)**

To report the offset for the upstream Baratron, enter:

**@@@254OBA?;FF**

An example response, if the offset is 0 Volts, is:

@@@000ACK0 ; FF

To change the offset to 0.007, enter:

**@@@254OBA!7;FF**

**How To Set the Offset for the Downstream Baratron (P2)**

To report the offset for the downstream Baratron, enter:

**@@@254OBB?;FF**

An example response, if the offset is 0 is:

@@@000ACK0 ; FF

To change the offset to -0.003, enter:

**@@@254OBB!-3;FF**

## How To Set the Nozzle Diameter

This function sets the diameter of the nozzle.

### Note



---

The software uses a multiple of “1,000” to calculate the value of the nozzle diameter.

- The *actual* range is 0.001 to 0.25 inches; the initial value is application dependent.
  - The acceptable *input* range is 1 to 250 inches.
- 

To report the size of the nozzle diameter, enter:

```
@@@254ND_?;FF
```

An example response, if the nozzle diameter is 0.064 inches, is:

```
@@@000ACK64;FF
```

## How To Set the Valve Current

This function sets the current, in mA, required to operate the valve.

### Note



---

The software uses a multiple of “100” to calculate the value of the valve current.

- The *actual* range is 0 to 150 mA; the initial setting is application dependent.
  - The acceptable *input* range is 0 to 15,000.
- 

To report the valve current, enter:

```
@@@254SIV?;FF
```

An example response, if the current is 150 mA, is:

```
@@@000ACK15000;FF
```

To change the valve current to 25 mA, enter:

```
@@@254SIV!2500;FF
```

## How To Report the Temperature Control Parameters

These functions report the temperature control parameters E and G, used in the flow control calculations. The temperature of the 1153 MFC (like the flow) is controlled by the CPU using a PI algorithm.

### Note



---

The temperature control parameters are set at the factory and should not be modified.

---

### *How To Report the Temperature Control Parameter E*

The temperature control parameter E is reported with the “ET\_” command.

To report the factory set value of “ET\_”, enter:

```
@@@254ET_?;FF
```

The response is:

```
@@@000ACK900;FF
```

### *How To Report the Temperature Control Parameter G*

The temperature control parameter G is reported with the “GV\_” command.

### Note



---

The software uses a multiple of “100” to calculate the value of “GT\_.”

- The *actual* factory set value is 0.01.
  - The *reported* value is 1.
- 

To report the factory set value of “GV\_”, enter:

```
@@@254GV_?;FF
```

The response is:

```
@@@000ACK1;FF
```

## How To Set the Overall Calibration Constant

The calibration data for each of the cardinal set points is entered using the “FCP” command (refer to *How To Setup the Calibration Constant Table*, page 61). The “CON” command is used to enter an overall calibration constant that is applied for all flow rates. Typically, this parameter is set to 1.0 and only the table of calibration constants is used.

### Note



---

The software uses a multiple of “1,000” to calculate the value of the calibration constant.

- The *actual* range is 0.001 to 2, with an initial value of 1.
  - The acceptable *input* range is 1 to 2,000.
- 

To report the value of the calibration constant, enter:

**@@@254CON?;FF**

An example response, if the value of the calibration constant is 1, is:

**@@@000ACK1000;FF**

To change the value of the calibration constant to 1.5, enter:

**@@@254CON!1500;FF**



## Appendix D: RS-232 Command Summary

The RS-232 command summary in Table 16 lists the Setup, Control, Informational, and Application Specific commands *in the order they appear in the main text*. For more information on each command, refer to *Chapter Five: RS-232 Operation*, page 41, and *Appendix C: Application Specific Parameters*, page 87.

<b>RS-232 Command Summary</b>			
<b>Command</b>	<b>Description</b>	<b>Multiple</b>	<b>Data Variables / Response</b>
CC_	Baud Rate	None	Enter 1,200; 2,400; 4,800; 9,600. Initial setting is 9,600.
CSF	Comm State Flag	None	Enter ANALOG or DIGITAL. Initial setting is ANALOG.
FSR	Full Scale Range - Flow	10	Enter 1 to 4,000,000. Actual range is 0.1 to 400,000 sccm. Initial value is application dependent.
FST	Full Scale Range - Temperature	None	Enter 100 to 500. Initial value in ° C / 5 V is application dependent.
MXT	Maximum Temperature	None	Enter 0 to 210. Initial setting in ° C is application dependent.
K_ _	K Constant	100	Enter 105 to 200. Actual range is 1.05 to 2. Initial value is 1.1.
EV_	Valve Control Parameter E "Phase Lead"	100	Enter -32,000 to 32,000. Actual range is -320 to 320 seconds. Initial value is application dependent.
GV_	Valve Control Parameter G "Gain"	100	Enter 1 to 32,000. Actual range is 0.01 to 320. Initial value is application dependent.
CVM	Minimum Valve Conductance (Cv)	100,000	Enter 1 to 500,000. Actual range is 0.00001 to 5 liter/sec (l/s). Initial value is application dependent.

Table 16: RS-232 Command Summary  
(Continued on next page)

<b>RS-232 Command Summary (Continued)</b>			
<b>Command</b>	<b>Description</b>	<b>Multiple</b>	<b>Data Variables / Response</b>
CVX	Maximum Valve Conductance (Cv)	100,000	Enter 1 to 500,000. Actual range is 0.00001 to 5 liter/sec (l/s). Initial value is application dependent.
CIM	Minimum Valve Current	100	Enter 0 to 15,000. Actual range is 0 to 150 mA. Initial setting is application dependent.
CIX	Maximum Valve Current	100	Enter 0 to 15,000. Actual range is 0 to 150 mA. Initial setting is application dependent.
MM_	Molecular Weight	10	Enter 1 to 10,000. Actual range is 0.1 to 1,000 grams per mole (g/mol). Initial value is application dependent.
FTR	Full Scale Flow Range of the Calibration Constant Table	10	Enter 1 to 4,000,000. Actual range is 0.1 to 400,000 sccm. Initial value is application dependent.
FCP	Calibration Constant Table	j = None Value = 1,000	Enter “j, value”, where: j = 0 to 10 value = 1 to 2,000 Actual range is 0.001 to 2
SUD	Save Current Data into EEPROM	None	None
RFD	Reset the Variables from the Factory Defaults	None	None
FSP	Flow Set Point	1,000	Enter 0 to 400,000,000. Actual range is 0 to 400,000; no initial setting.
TSP	Temperature Set Point	100	Enter 0 to (Max Temp x 100). Actual range is 0 to Max Temp; no initial setting.

Table 16: RS-232 Command Summary  
(Continued on next page)

<b>RS-232 Command Summary (Continued)</b>			
<b>Command</b>	<b>Description</b>	<b>Multiple</b>	<b>Data Variables / Response</b>
TOF	Temperature Controller OFF	None	None
TON	Temperature Controller ON	None	None
OPV	Open Valve	None	None
CLV	Close Valve	None	None
CTV	Control Valve	None	None
T__	System Status	None	Indicates the state of the system. Refer to Table 12, page 70.
SR_	Status Reset	None	Clears the reset bit in the system status byte.
VER	Software Version	None	Reports the software version number.
CF_	Flow	1,000	Reports the current gas flow through the unit in sccm. Reported and actual flow values are application dependent.
CT_	Temperature	100	Reports the current temperature in the unit in degrees Celsius (° C). Reported range is 0 to 20,000. Actual range is 0 to 200° C.
RPA	Pressure of Upstream Baratron (P1)	1,000	Reports the pressure in Torr. Reported and actual pressure ranges are application dependent.
RPB	Pressure of Downstream Baratron (P2)	1,000	Reports the pressure in Torr. Reported and actual pressure ranges are application dependent.
VSF	Valve State	None	Reports the position of the valve as OPEN, CLOSED, or CONTROL.

Table 16: RS-232 Command Summary  
(Continued on next page)

<b>RS-232 Command Summary (Continued)</b>			
<b>Command</b>	<b>Description</b>	<b>Multiple</b>	<b>Data Variables / Response</b>
RP_	Required Power	100	Reports the power required for the heater to maintain or reach the set point. Reported range is 0 to 20,000. Actual range is 0 to 200 Watts.
FCA	Discharge Coefficient	1,000	Reports the value of the discharge coefficient being used in the current flow calculations. Reported range is 1 to 2,000. Actual range is 0.001 to 2.
VRF	V reference	10,000	Reports the system voltage. When the system is operating properly, this value should be close to 5 Volts.
CA_*	Change Address	None	Enter 1 to 253. Initial address is 254.
RBA*	Full Scale Range - Upstream Baratron (P1)	None	Enter 1 to 10,000. Initial setting, in Torr, is application dependent.
RBB*	Full Scale Range - Downstream Baratron (P2)	None	Enter 1 to 10,000. Initial setting, in Torr, is application dependent.
GBA*	Gain of Upstream Baratron (P1)	1,000	Enter 1 to 2,000. Actual range is 0.001 to 2. Initial setting is 1.
GBB*	Gain of Downstream Baratron (P2)	1,000	Enter 1 to 2,000. Actual range is 0.001 to 2. Initial setting is 1.
OBA*	Offset of Upstream Baratron (P1)	1,000	Enter -2,000 to 2,000. Actual range is -2 to 2 Volts. Initial setting is 0 Volt.
OBB*	Offset of Downstream Baratron (P2)	1,000	Enter -2,000 to 2,000. Actual range is -2 to 2 Volts. Initial setting is 0 Volt.

Table 16: RS-232 Command Summary  
(Continued on next page)

RS-232 Command Summary (Continued)			
Command	Description	Multiple	Data Variables / Response
ND_*	Nozzle Diameter	1,000	Enter 1 to 500. Actual range is 0.001 to 0.25 inches. Initial setting is application dependent.
SIV*	Valve Current	100	Reports 0 to 15,000. Actual range is 0 to 150 mA. Initial setting is application dependent.
ET_*	Temperature Control Parameter E	None	Factory set value is 900.
GT_*	Temperature Control Parameter G	100	Reports 1. Actual factory set value is 0.01.
CON*	Calibration Constant	1,000	Enter 1 to 2,000. Actual range is 0.001 to 2. Initial value is 1.
* These parameters are application specific and <b>should not be used</b> unless you have consulted MKS Instruments for assistance. Refer to <i>Appendix C: Application Specific Parameters</i> , page 87, for more information.			

Table 16: RS-232 Command Summary

This page intentionally left blank.

## Appendix E: ASCII Value Chart

ASCII Value Chart					
Character	ASCII Code (decimal)	Character	ASCII Code (decimal)	Character	ASCII Code (decimal)
(sp)	32	3	51	F	70
!	33	4	52	G	71
"	34	5	53	H	72
#	35	6	54	I	73
\$	36	7	55	J	74
%	37	8	56	K	75
&	38	9	57	L	76
'	39	:	58	M	77
(	40	;	59	N	78
)	41	<	60	O	79
*	42	=	61	P	80
+	43	>	62	Q	81
,	44	?	63	R	82
-	45	@	64	S	83
.	46	A	65	T	84
/	47	B	66	U	85
0	48	C	67	V	86
1	49	D	68	W	87
2	50	E	69	X	88

Table 17: ASCII Value Chart  
(Continued on next page)

ASCII Value Chart ( <i>Continued</i> )					
Character	ASCII Code (decimal)	Character	ASCII Code (decimal)	Character	ASCII Code (decimal)
Y	89	f	102	s	115
Z	90	g	103	t	116
[	91	h	104	u	117
\	92	i	105	v	118
]	93	j	106	w	119
^	94	k	107	x	120
_	95	l	108	y	121
`	96	m	109	z	122
a	97	n	110	{	123
b	98	o	111		124
c	99	p	112	}	125
d	100	q	113	~	126
e	101	r	114		127

Table 17: ASCII Value Chart



## Index

### A

Analog operation, 39–40

### B

Baratrons

full scale range, 89

gain, 90

introduction, 5

offset, 91

zero adjust, 79

Baud rate, 52

### C

Calibration

data sheet, 34

description of, 33

parameters, 35

Calibration constant table

full scale range, 60

setup, 61

Checksum

command or request, 45

response, 47

Comm state flag, 52

Command or request

checksum, 45

description of, 44

sending, 46

Connectors, 18

AC power, 22

DC power, 21

Interface, 20

pinouts, 18

RS-232, 19

Control messages, 63–67

Customer support, 7

### D

Data format, 49

Differential pressure, 13

Digital RS-232 operation

command summary, 95–99

communication parameters, 42

control messages, 63–67

data format, 49

informational messages, 68–75

protocol, 43–48

setup messages, 50–62

Dimensions

baseplate, 12

front panel, 11

side panel, 12

### E

Electrostatic discharge, 18, 24, 80

Error codes, 48

### F

Full scale range

Baratrons, 89

calibration constant table, 60

- flow, 53
  - temperature, 53
  - unit, 5
- G**
- Gain
- command, 56
  - when to adjust, 29
- Gas source
- feed line conductance, 15
  - feed line temperature, 14
  - maximum inlet pressure, 13
- I**
- Informational messages, 68–75
- L**
- Labels
- serial number label, 38
  - warning label, 38
- LED, 25
- M**
- Maintenance, 77
- Baratrons zero adjust, 79
  - system checks, 78
- Manual organization, 6
- Maximum inlet pressure, 13
- Model code, 85
- Mounting instructions, 16
- N**
- Nozzle, 92
- O**
- Operation
- analog, 39–40
  - digital RS-232, 41–76
  - start up, 23
  - status LED, 25
- Orientation, 10, 16
- Oscillation, 14, 29, 81
- Overpressure limit, 13
- P**
- Phase lead
- command, 56
- Power requirements, 10, 13
- Pressure
- reporting, 73
- R**
- Rear panel, 18
- Reset
- parameters, 62
  - system status bit, 71
- Response
- description of, 47
- Returning the product, 7, 9, 77
- S**
- Safety information
- messages, definitions of, 1
  - safety procedures and precautions, 3–4
  - symbols, 2
- Saving data, 62
- Seal material, 5

Serial number label, 38

Set point

flow, 40, 64

temperature, 39, 65

Setup

mounting instructions, 16

power requirements, 10, 13

product location and requirements, 10

RS-232 messages, 50–62

Specifications, 83–84

Start up, 23

default mode, 24

LED, 25

warm up time, 24

Status

LED, 25

system status byte, 70

System configuration

example of, 35

typical setup, 17

System status byte, 70

reset bit, 23, 71

## T

Temperature

ambient, 10

components, 72

full scale range, 53

maximum temp, 54

operating, 13

set point, 39, 65

warm up time, 24

Theory

mass flow measurement, 27

proportional - integral control, 29

Transducers. *See* Baratron

Troubleshooting, 80

## V

Valve

conductance levels, 57

current levels, 58

orifice size, 32

Valve control

reporting, 74

setting, 40, 67

Valve control constants

gain, 56

phase lead, 56

Ventilation, 10

## W

Warm up time, 24

Warning label, 38

## Z

Zero adjust, 79