

Microvision 2

Stability, Accuracy and Speed
The RGA Your Process Can Rely On



Whether your application is leak checking a sputtering chamber, obtaining the highest vacuum possible in a synchrotron or precisely controlling a thin film deposition layer, the cost of not understanding the details of the gases in your vacuum chamber can be very expensive. During the last decade residual gas analysis (RGA) has evolved into a rugged sensor technique, integrated into automated process control environments to provide vital information to engineers on errors within the process and warn when parameters are starting to move out of control.

Microvision 2 is the latest innovation in RGA technology from MKS, designed to meet all of the traditional requirements for an RGA sensor but with data collection at speeds unachievable with previous generation technologies. In addition, the Microvision 2 is designed to collect data at millisecond speeds per data point even when measuring data over the full dynamic range of the RGA. This capability has been achieved without sacrificing any of the necessary robustness, reliability and support which have made MKS the world leader in RGA products over the widest range of applications from semiconductor tools or particle accelerators to general industrial applications.

Product Features



The constant challenges for RGA technology are to:

- Provide the highest sensitivity measurements of the gas species present in a vacuum
- Have robust sensors that keep working even in harsh process environments
- Acquire the highest quality of data at the fastest possible speeds
- Integrate seamlessly into the widest possible range of hardware and software systems

Key Benefits

- Collects data at millisecond speed
- Offers the highest flexibility and connectivity through the use of industry standard communication
- Optimizes the roles required of a complex sensor
- Provides a complete range of additional digital and analog connections for integrated systems

Technology Leadership

MKS was the first company to offer an RGA compatible with modern Ethernet based web-enabled wide area network installations. Microvision 2 continues this development to a level that offers the highest flexibility and connectivity through the use of industry standard communication hardware and software.



Microvision 2 is the heart of the Vision 2000 series of process monitoring RGAs

Microvision 2 optimizes the roles required of a complex sensor by having two dedicated processors:

- An optimized, proprietary processor for data acquisition
- An industry standard CE operating system processor for external communications through field proven TCP-IP technology

The advantages of this design approach are fast, accurate data from a robust RGA sensor using industry standard, flexible communication protocols. Microvision 2 also provides a complete range of additional digital and analog connections for integrated systems at the best possible value for your investment.

Hardware Value & Performance

Sensors

Microvision 2 has field proven quadrupole mass analyzer designs with pre-filters and optional post filters for:

- Greater resistance to the effects of contamination than a single filter
- Greater sensitivity at higher masses compared to single filters, critical to monitoring many molecules used in CVD processes
- Wide range of ion sources
- Twin independent filaments as standard to ensure minimum downtime during critical process monitoring
- Standard dual detector including a faraday detector and microchannel plate electron multiplier for detection to $e-14$ mbar partial pressures

Graph showing detector settling time when jumping to a mass with no signal from different masses within the measurement range of the detector

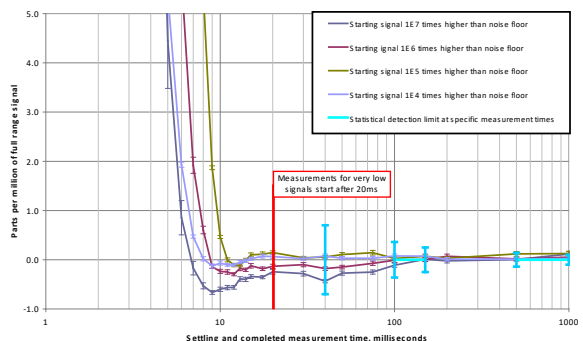

Signals close to the noise floor can still be reliably measured, even immediately after measuring very large signals

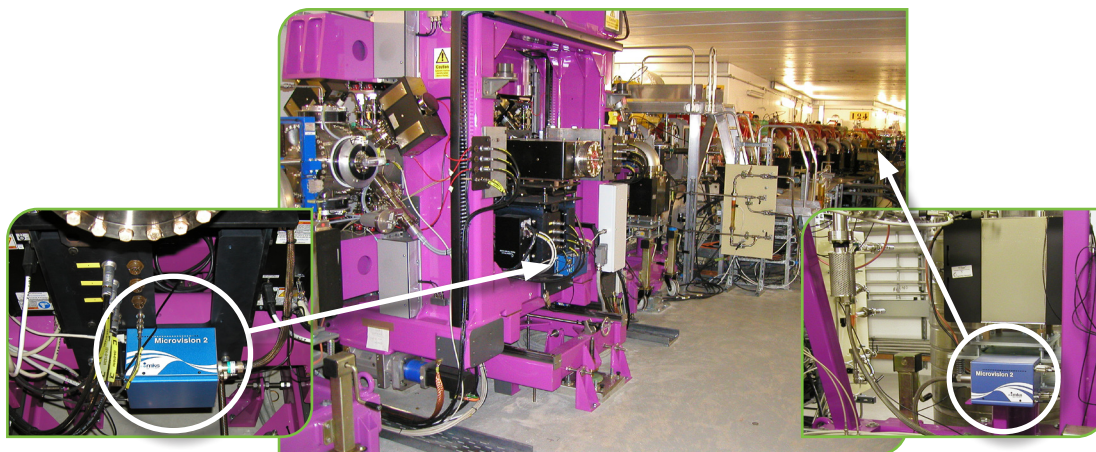

Microvision 2 RGAs in situ on a latest generation synchrotron storage ring. Images courtesy of Diamond Light Source, UK.

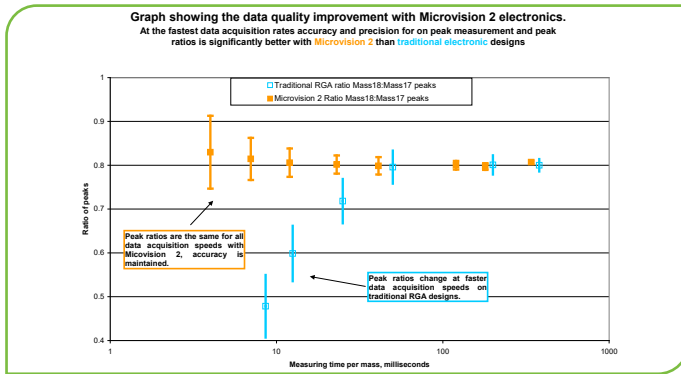

Faster and more accurate responses are possible in closed-loop control applications where the RGA is process critical

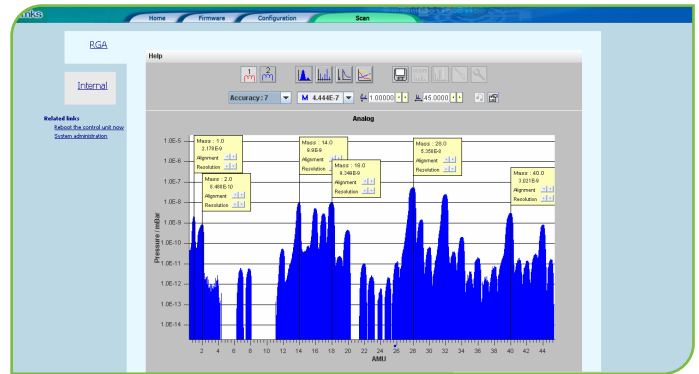

Built-in web application for Microvision 2 control and data acquisition

Electronics

Data acquisition occurs through all solid state, wide dynamic range, fast settling detector electronics:

- Prevents large peaks from causing false positive measurements on small peaks
- Temperature stabilized critical components with improved signal stability and baseline drift allow the unit to be used without frequent recalibration if the vacuum chamber is stable but ambient air temperature fluctuates
- Variable sensor conditions to match the needs of each process
- Each optimization is separately stored in the RGA and automatically recalled or recalibrated by software recipes
- Flexible digital and analog I/O capability with a dedicated gauge port as standard
- Option to add extra levels of I/O and communications ports built into the RGA electronics

Controls

A web interface using industry standard technology allows control of the Microvision 2 as well as calibration, operation and data export through a non platform-specific web browser from anywhere on a network.

Using the documented ASCII protocol and TCP-IP communication, any third party software can send and receive commands and data from the Microvision 2.

Software Flexibility & Scalability without Compromise

In addition to the standard, built-in web applications, software control is also available through three Windows applications, offering the best possible fit to any customer's requirements.

EasyView – provides basic RGA controls but with more functionality than the built-in web application:

- Store RGA data and review it later in the Recall viewer
- Annotate graphs with notes stored into the data files
- Run several RGAs from one software package

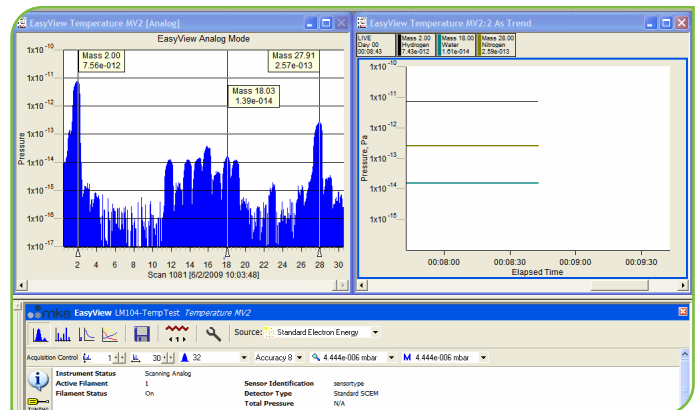

EasyView for simple control and data collection with multiple RGAs

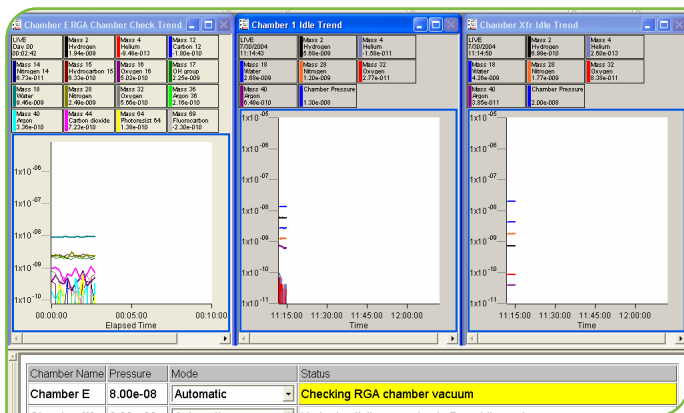

Process Eye Professional for flexible control through recipe-driven data collection

Process Eye Professional – offering complete control of all RGA parameters:

- Recipe driven control to allow the highest level of flexibility but with ease of use through the EasyView recipe and Recipe Wizard
- Ability to link to other systems through a variety of mechanisms such as Modbus, ASCII, SECS protocols, serial communications, TCP-IP, file exchange and many others
- Flexibility to run customized data collection, alarm condition checking and closed loop control operations

TOOLweb RGA – specialized tool integration software providing optimized methods to get the most reliable information from RGAs on process tools:

- Complete integration of RGA data with tool operation and FDC systems
- Levels of interdiction from passive monitoring of the tool vacuum, to process critical go/stop control of individual process chambers
- Powerful web based reporting provides process engineers with highly valuable information to keep tools running at peak efficiency

Applications

Microvision 2 is useful in a wide range of situations where knowing the contents of your chamber is critical to the success of your process.

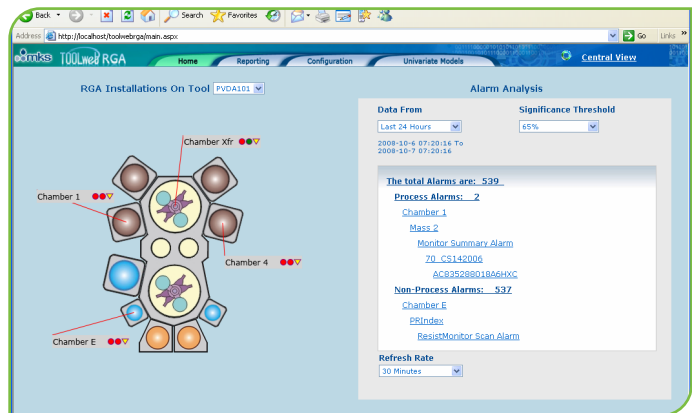

TOOLweb RGA for complete integration with tool and factory process control

Semiconductor Manufacturing

Microvision 2 complements other MKS RGAs and is available in a range of configurations which are optimized for specific semiconductor needs:

Vision 2000-B: equipped with slit valve pressure sensors connected to the Microvision 2 digital IO, this RGA is valuable on any high vacuum cluster tool. It can detect the smallest leaks which would not be identified by a total pressure sensor, and synchronize alarm limit checks with slit valve movements at millisecond precision to determine the exact component at fault.

300mm ResistTorr: Microvision 2 fitted into a process-optimized differentially pumped vacuum system with a capillary inlet and independent calibration bottle, can prevent losing thousands of dollars on scrap wafers due to photoresist contamination in PVD tools.

Other standard and custom configurations are available for low pressure and near atmospheric pressure furnace tools, RTP and general leak checking applications.



Microvision 2 installed as a 300mm Resist-Torr on a PVD tool degas chamber

Large Scale Coating Tools

Microvision 2 is available in various configurations to augment other MKS RGAs and match the needs of both cluster based and in-line large scale coating tools.

Vision 2000-P: Microvision 2 can be fitted into a process-optimized, differentially pumped vacuum system with a single path inlet designed to minimize response times to changes in higher pressure PVD processes. This RGA gives the best possible detection limits for monitoring contamination in the process chamber.

Vision 2000-C/E: Microvision 2 fitted into a process-optimized, corrosion-protected, differentially pumped vacuum system with a dual path, purge-protected sampling inlet can help optimize the gas use and monitor the vacuum quality of CVD, chamber clean and wafer etch processes.

The Choice for High Mass Performance

Microvision 2 systems incorporate a pre-filtered analyzer as standard. While protecting the main filter from a gradual buildup in contamination, the contamination resistant RF-only pre-filter also strongly focuses ions exiting the ion source, thereby improving both resolution and transmission (a measure of ions successfully traveling between the ion source and the detector). The optional triple filter analyzer has both pre- and post-filters for further improvements in the transmission of higher mass species.

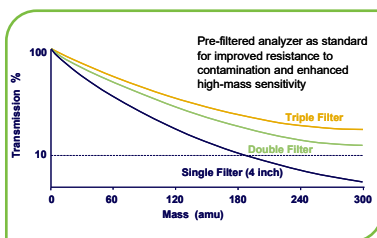

The Choice for High Resolution Performance

A special model of MicroVision 2 is available for applications requiring high peak resolution. Incorporating high frequency RF electronics, this unit has a mass range of 1-6 amu and used in conjunction with a triple filter analyzer, it is able to resolve helium and deuterium at mass 4.

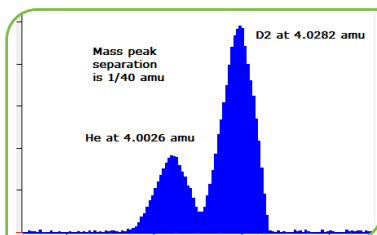

Ultra-High Vacuum Quality

Microvision 2 with an open ion source analyzer is suitable for many high vacuum RGA applications. For UHV pressures, a high performance UHV source option is available. This source incorporates a platinum source cage to reduce electron stimulated desorption of gas species. For fast degassing and minimal out-gassing, the UHV source is based on a low thermal inertia design, and the components are vacuum fired prior to assembly.



Operation in Harsh Environments

Certain applications require the RGA to operate in an environment that could damage the electronics when they are directly coupled to the analyzer.



Microvision 2 systems can be supplied with special extenders that allow the analyzer to be operated in harsh environments (e.g. high temperature and/or ionizing radiation) with the control electronics located in a safe or shielded position. Two extenders are available (3 meters and 15 meters), each incorporating a radiation resistant cable and a high temperature analyzer interface. This assembly provides a thermal break so that the high flange temperature of the analyzer is not conducted to the wiring loom connecting the RGA to the electronics. Analyzers can then be operated at temperatures of up to 200°C for faraday detection and 150°C for multiplier detection.

Microvision 2 Electronics	
Mounted Weight on Flange	1.7kg
Power	24V DC, 3A external universal voltage supply (included)
Max. Operating Conditions	Electronics: 40°C, 80% RH (non condensing)
Communication	10/100 Base-T Ethernet, static or automatically assigned IP addresses
Data Acquisition Method	Dedicated real time acquisition processor
Data Collection Methods	<ul style="list-style-type: none"> • Analog scanning, full mass range 8, 16 or 32 points/amu • Barchart scanning • Peak-jump collection of up to 15 peaks per scan • Complete recipe control to link multiple acquisition into a single scan (Process Eye Professional and TOOLweb RGA only)
Number of Stored Source Settings	<ul style="list-style-type: none"> • 6 sets including ion source parameters, alignment, resolution, detector calibrations • Stored in electronics and recalled by EasyView, Process Eye Professional or TOOLweb RGA
Software Controlled Tuning Parameters	<ul style="list-style-type: none"> • Electron energy, 20 to 100eV • Emission current, 0 to 2 mA (5 mA degas) • Ion energy, 0 to 10V • Ion extraction, 0 to -130V • Filter pole bias, 0 to -10V to +10V
Multiplier Protection	Automatic removal of over-range peaks from all scan modes, dedicated multiplier inhibit line for over temperature or over-pressure and X-trip filament and multiplier protect for over-pressure
Data Acquisition Speed	< 3ms per point for analog scanning
Settling Time to 1 ppm of Maximum Signal	<20ms
Control Method	CE operating system processor with web-server interface
Command Structure	Documented ASCII command protocols
Software	<ul style="list-style-type: none"> • Built-in web applications allowing RGA control and data acquisition using a platform independent web browser without the need for dedicated installed software • EasyView, Process Eye Professional and TOOLweb RGA Windows software packages for Windows 2000, XP, or Vista
Interfaces	<ul style="list-style-type: none"> • RJ45 socket: 10/100 Base-T Ethernet • 25 way D-type female: 16 configurable TTL I/O, one dedicated multiplier over temperature inhibit input, includes power for ±15V (100mA), +24V (100mA) and ±3.3V (100mA) • 15 way D-type female: 4 analog in (-11V to +11V 22bit), 2 analog outputs (0-10V 12bit), includes power for ±15V (100mA), compound output from detector pre-amplifier • 9 way D-type female dedicated vacuum gauge port: -11 to +11V 22bit analog input, 1 digital input (gauge OK), 1 digital output (gauge enable) and gauge power +24V (100mA) • 3.5mm jack socket: Opto-isolated input for filament protect or control with auto detection of presence of the jack plug as failsafe • 2.5mm jack socket: Audio output for use with speaker and wired or wireless headphones

Microvision 2 Analyzers	Double (standard configuration)	5" Single	Triple
Ranges, amu	100, 200, 300	100, 200	1-6, 100, 200, 300
Max. Operating Pressure	7.6e-5 Torr (1e-4 mbar)	7.6e-5 Torr (1e-4 mbar)	7.6e-5 Torr (1e-4 mbar)
Ion Source Sensitivity	2e-4 A/mbar	2e-4 A/mbar	2e-4 A/mbar
Min. Detectable Partial Pressure, Open Ion Source	3 standard deviations of baseline noise at 300ms integration	3 standard deviations of baseline noise at 300ms integration	3 standard deviations of baseline noise at 300ms integration
Faraday	1.5e-11 Torr (2e-11 mbar)	1.5e-11 Torr (2e-11 mbar)	1.5e-11 Torr (2e-11 mbar)
Microchannel Plate	3.8e-14 Torr (5e-14 mbar)	3.8e-14 Torr (5e-14 mbar)	3.8e-14 Torr (5e-14 mbar)
Single Channel EM	n/a	n/a	7.6e-15 Torr (1e-14 mbar)
Bakeout Temperature	250°C (with extender or electronics removed)	250°C (with extender or electronics removed)	250°C (with extender or electronics removed)
Operating Temperature	<ul style="list-style-type: none"> • 200°C (Faraday only with electronics at 10-40°C) • 150°C (multiplier detection with electronics 10-40°C and pressure <1e-8 mbar) • 90°C (multiplier detection with electronics 10-40°C and pressure <1e-5 mbar) 	<ul style="list-style-type: none"> • 200°C (Faraday only with electronics at 10-40°C) • 150°C (multiplier detection with electronics 10-40°C and pressure <1e-8 mbar) • 90°C (multiplier detection with electronics 10-40°C and pressure <1e-5 mbar) 	<ul style="list-style-type: none"> • 200°C (Faraday only with electronics at 10-40°C) • 150°C (multiplier detection with electronics 10-40°C and pressure <1e-8 mbar) • 90°C (multiplier detection with electronics 10-40°C and pressure <1e-5 mbar)
Filament Materials	Tungsten or Thoria coated Iridium	Tungsten or Thoria coated Iridium	Tungsten or Thoria coated Iridium
UHV Ion Source	Option	Standard	Option
UHV Out-Gassing Rate	<1e-9 mbar -l/s	<1e-9 mbar -l/s	<1e-9 mbar -l/s
PVD Ion Source	Option	n/a	Option
Cross Beam Ion Source	Option	n/a	Option
Resolution	Better than 10% valley for peaks of equal height across mass range	Better than 10% valley for peaks of equal height across mass range	Better than 10% valley for peaks of equal height across mass range
Peak Position Drift	±0.1 amu over 8 hours at stable flange temperature	±0.1 amu over 8 hours at stable flange temperature	±0.1 amu over 8 hours at stable flange temperature
Zero Blast Effect at Mass 2 (closed ion source)	<5 ppm baseline levels next to mass 2	n/a	<5 ppm baseline levels next to mass 2
Flange Fitting	DN 40 CF-F	DN 40 CF-F	DN 40 CF-F
Compliance	CE		

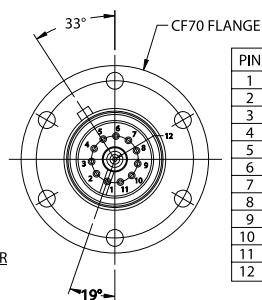
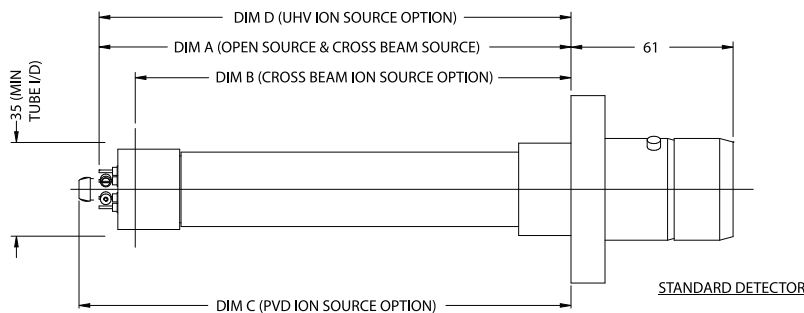
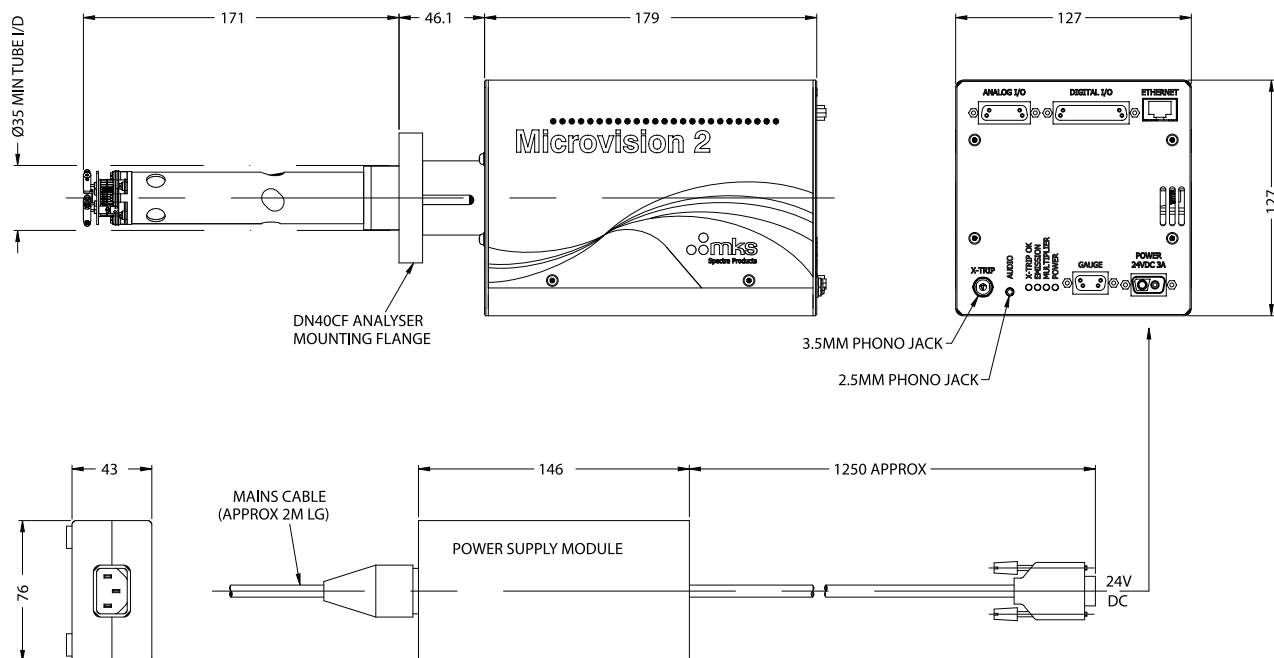

PIN	CONNECTION
1	EARTH
2	SOURCE PLATE
3	SEM
4	FILAMENT 1
5	EXTRACTOR
6	SUPPRESSOR
7	RF1
8	REPELLER
9	N/C
10	FILAMENT 2
11	RF2
12	COLLECTOR

ANALYSER VERSION	DIM A	DIM B	DIM C	DIM D
4" SINGLE FILTER	151.70	138.15	156.65	146.70
5" SINGLE FILTER	176.70	163.15	181.65	171.70
DOUBLE FILTER	176.70	163.15	181.65	171.70
TRIPLE FILTER	225.70	212.15	230.65	220.70
TRIPLE FILTER/CHANNELTRON	301.50	287.95	306.45	296.50

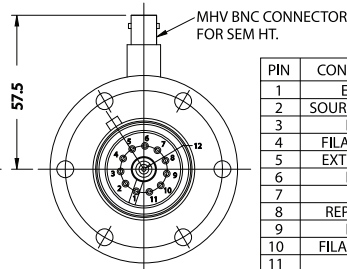
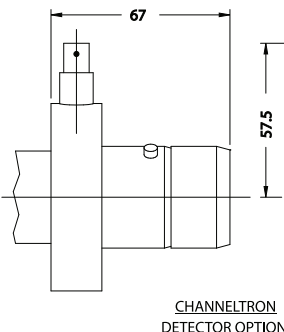

PIN	CONNECTION
1	EARTH
2	SOURCE PLATE
3	N/C
4	FILAMENT 1
5	EXTRACTOR
6	N/C
7	RF1
8	REPELLER
9	N/C
10	FILAMENT 2
11	RF2
12	COLLECTOR

Dimensional Drawing
Unless otherwise specified, dimensions are nominal values in millimeters.