

40 mm Plasma Source Dimensional Drawing. Shown with KF40 flanges.
 Note: Unless otherwise specified, dimensions are nominal values in inches (mm referenced).

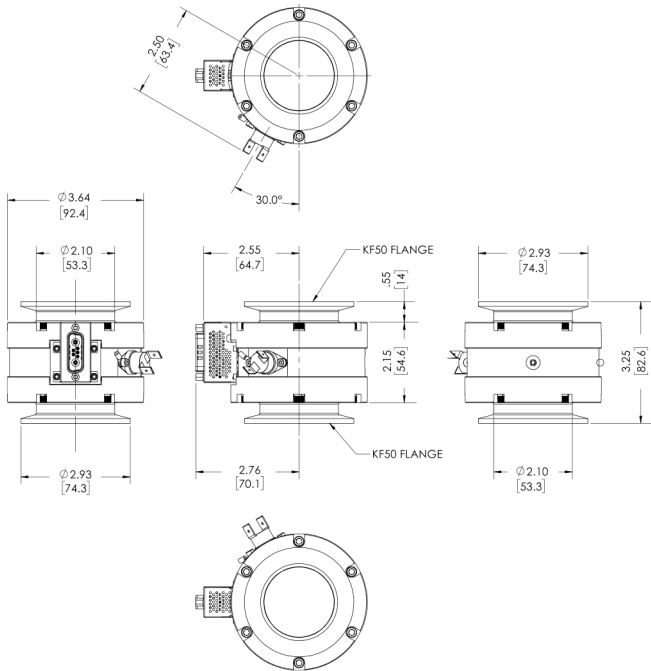

50 mm Plasma Source Dimensional Drawing. Shown with KF50 flanges.
 Note: Unless otherwise specified, dimensions are nominal values in inches (mm referenced).

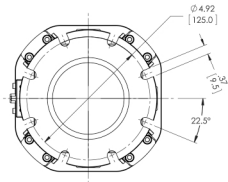
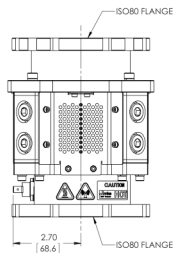
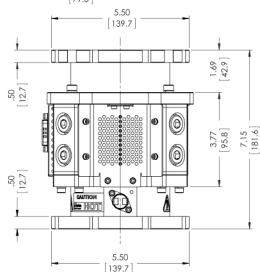
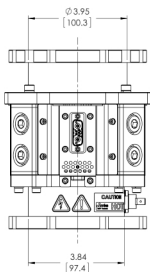
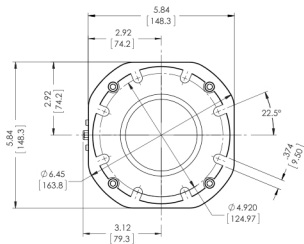

80 mm Plasma Source Dimensional Drawing. Shown with ISO80 flanges.
 Note: Unless otherwise specified, dimensions are nominal values in inches (mm referenced).

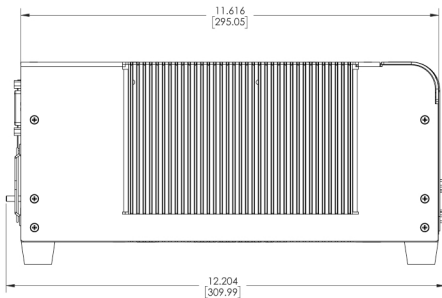
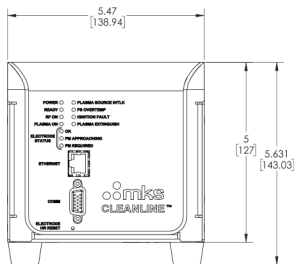
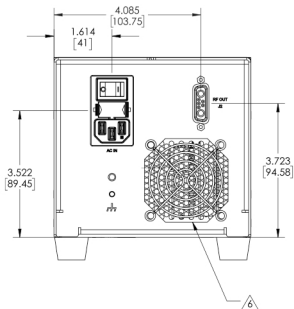

 MINIMUM OF 75MM CLEARANCE REQUIRED FOR INTAKE AND EXHAUST VENTS.

Note: Unless otherwise specified, dimensions are nominal values in inches (mm referenced).