

Technology Manual

# HIGH ACCURACY MASS FLOW VERIFIER (HAMFV)



Copyright © 2022 by MKS Instruments, Inc.

All rights reserved. No part of this work may be reproduced or transmitted in any form or by any means, electronic or mechanical, including photocopying and recording, or by any information storage or retrieval system, except as may be expressly permitted in writing by MKS Instruments, Inc.

Printed in the United States of America

mksinst™ is a trademark of MKS Instruments, Inc.

DeviceNet is a trademark of Open DeviceNet Vendor Association, Inc., Coral Springs, FL

EtherCAT is a trademark of Beckhoff Automation GmbH

HA-MFV is a registered trademark of MKS Instruments, Inc., Andover, MA Baratron® is a registered trademark of MKS Instruments, Inc., Andover, MA

Swagelok®, VCO®, and VCR® are registered trademarks of Swagelok Company, Solon, OH Inconel® is a registered trademark of Inco Alloys, Inc. Huntington, WV

All other product names herein are used for identification purposes only and are recognized as properties (including trademarks, registered trademarks, and referenced copyrighted materials) of their respective companies.

Protected by U. S. patents pending and foreign patents pending.

## Table of Contents

List of Figures and Tables .....	7
1 Warranty .....	9
2 Safety Information .....	10
2.1 Symbols Used in This Instruction Manual .....	10
2.2 Symbols Found on the Unit .....	10
2.3 Safety Procedures and Precautions .....	11
2.4 Sicherheitshinweise für das Massenflussgerät .....	13
2.4.1 In dieser Betriebsanleitung vorkommende Symbole ual .....	13
2.4.2 Erklärung der am Gerät angebrachten Symbole .....	13
2.4.3 Sicherheitsvorschriften und Vorsichtsmaßnahmen .....	14
2.5 Informations de sécurité pour appareils de mesure/contrôle de débit massique .....	16
2.5.1 Symboles utilisés dans ce manuel d'utilisation .....	16
2.5.2 Symboles figurant sur l'unité .....	16
2.5.3 Mesures de sécurité et précautions .....	17
2.6 Medidas de seguridad del dispositivo de flujo de masa .....	19
2.6.1 Símbolos usados en este manual de instrucciones .....	19
2.6.2 Símbolos hallados en la unidad .....	19
2.6.3 Procedimientos y precauciones de seguridad .....	20
2.7 マスフロー機器の安全に関する情報 .....	22
2.7.1 この取扱説明書で使用されているシンボル .....	22
2.7.2 本機器のマーク .....	22
2.7.3 安全対策について .....	23

2.8	질량 유량 장치 안전 정보 .....	25
2.8.1	본 지침 매뉴얼에 사용되는 기호들 .....	25
2.8.2	장치에 표시된 기호들 .....	25
2.8.3	안전 절차 및 예방조치 .....	26
3	Overview .....	29
3.1	Product Support Documents .....	30
3.2	Manual References .....	30
3.3	Rate of Rise Mass Flow Verification .....	30
3.4	HA-MFV Design and Operation .....	32
3.5	HAMFV Product Features .....	32
3.5.1	Sonic Nozzles .....	32
3.5.2	Capacitance Manometer .....	33
3.5.3	RTD's .....	33
3.5.4	Volume and Manifolds .....	33
3.5.5	Isolation Valves .....	33
3.6	HA-MFV Reliability .....	33
3.7	HA-MFV Cleanliness .....	34
3.8	HA-MFV Specifications .....	34
4	HA-MFV Installation .....	38
4.1	HA-MFV Configuration Design for In-Situ Rate of Rise Measurement .....	38
4.2	Considering the HA-MFV Installation Environment .....	39
4.2.1	HA-MFV Installation Environment .....	39
4.2.2	Pre-Installation Safety Considerations .....	39

4.2.3	Unpacking the HA-MFV in a Clean Environment .....	40
4.2.4	Mounting Hardware for Installing the HAMFV .....	40
4.2.5	Establishing a Leak Tight Seal for the HA-MFV .....	41
4.2.6	Connect Pneumatic Airline to HA-MFV Fitting.....	42
4.2.7	Applying Power and Signal Cables to the HA-MFV.....	42
4.3	Digital I/O Connections .....	43
4.3.1	DeviceNet Communications Protocol .....	43
4.4	A-MFV EtherCat Communication.....	44
4.4.1	EtherCat Communication Protocol .....	44
4.5	Perform He Leak Check to Verify HA-MFV Seals.....	45
5	HA-MFV Operation .....	46
5.1	Pre-Operation Procedures .....	46
5.1.1	Warm Up Device Prior to Use.....	46
5.1.2	Perform Device Leak Check on HA-MFV .....	46
5.1.3	Perform a System Leak Check .....	47
5.1.4	Perform a Manifold Purge .....	48
5.1.5	Check Gas Type and Range Prior to Verification .....	49
5.1.6	Pump System Performance Verification .....	52
5.2	HA-MFV Operation Procedures .....	52
5.2.1	Flow Verification Service and Monitor for Completion.....	52
5.2.2	Read Measured Mass Flow Rate .....	53
6	Maintenance and Troubleshooting .....	54
6.1	General Information .....	54
6.2	Zeroing the MKS HA-MFV Mass Flow Verifier Pressure .....	54

- 6.3 When to Use Pressure Zero Adjust .....55
- 6.4 How to Use Pressure Zero Adjust.....55
- 6.5 Customer Support .....56
  - 6.5.1 Obtaining a Return Material Authorization (RMA) Number .....56
  - 6.5.2 Health and Safety Form .....57
- 6.6 Troubleshooting Guide .....57
- Appendix A Web Browser Tutorial.....59
  - Communicating with the HA-MFV via Ethernet UDP .....59
  - Opening the Web Browser – Monitor Mode .....62
  - Going to the Setup Mode .....63
  - Utilizing the Plot Page and Saving Data .....65
    - ToolWeb Folder .....65
    - Downloading Java from java.com .....66
    - Placing the java.policy in the C:drive Java Folder .....66
    - Creating a Java Security “Trusted” Site .....68
- Appendix B HAMFV Operation Flow Charts: DeviceNet I/O .....74
  - Flow Verification Service .....74
  - Zero Adjust Pressure Service.....75
  - Manifold Purge Service .....76
- Appendix C HAMFV Operation Flow Charts: Etherecat I/O .....77
  - Flow Verification Service .....77
  - Pressure Zero Adjust Service.....78
  - Manifold Purge Service .....79
  - MFV Device Leak Service .....80

MFV System Leak Service .....81

## List of Figures and Tables

Figure 1: High Accuracy Mass Flow Verifier - HAMFV.....29

Figure 2: HA-MFV Functional Block Diagram .....32

Figure 3: HA-MFV Installation Diagram 1 – Single Gas Box.....38

Figure 4: HA-MFV Diagram #2 – Multiple Chamber.....39

Figure 5: Front and Top View of HA-MFV .....41

Figure 6: Side View of HA-MFV.....41

Figure 7: DeviceNet I/O Connection Located on Electronics Enclosure .....43

Figure 8: DeviceNet 4-Position Rotary Switch for Baud Rate Selection .....43

Figure 9: DeviceNet Pair of Rotary Switches .....44

Figure 10: HA-MFV EtherCat I/O.....44

Figure 11: DeviceNet 4-Position Rotary Switch for Baud Rate Selection .....59

Figure 12: Local Area Connection Status.....60

Figure 13: Internet Protocol Version 4.....60

Figure 14: Properties .....61

Figure 15: IP Settings .....61

Figure 16: Web Browser Device Page in Monitor Mode .....62

Figure 17: Enter Password to Change Settings .....63

Figure 18: Additional Tabs.....64

Figure 19: Creating a ToolWeb Folder for Saving Data .....65

Figure 20: Java Web Site .....66

Figure 21: Java Folder from Download .....66

Figure 22: Java Security Folder.....67

Figure 23: New Java Policy Security Document .....67

Figure 24: Java Policy Security Document Placement.....68

Figure 25: Java Folder.....68

Figure 26: Java Control Panel - Security Tab .....69

Figure 27: Exception Site List.....69

Figure 28: Security Warning .....70

Figure 29: Security Window.....70

Figure 30: Plot Page .....71

Figure 31: Variable Selection and Real Time Plot.....72

Figure 32: ToolWeb Folder to Save Data .....72

Figure 33: File Successfully Saved in ToolWeb Folder.....73

Figure 34: File Flow Verification Service .....74

Figure 35: Zero Adjust Pressure Service.....75

Figure 36: Manifold Purge Service .....76

Figure 37: Flow Verification Service .....77

Figure 38: Pressure Zero Adjust Service.....78

Figure 39: Manifold Purge Service .....79

Figure 40: MFV Device Leak Service .....80

Figure 41: MFV System Leak Service .....81

Table 1: General Performance and Design Specification .....34

Table 2: Electrical Specification.....36

Table 3: Material and Mechanical Specification .....36

Table 4: HA-MFV Mass Flow Verification Range as a Function of Gas Type.....49

Table 5: Troubleshooting Guide .....57

Table 6: Basic Features in the Setup Mode .....64



# 1 Warranty

MKS Type HA-MFV Mass Flow Verifier (DeviceNet)

MKS Instruments, Inc. (MKS) warrants that for one (1) year from the date of shipment the equipment described above (the “equipment”) manufactured by MKS shall be free from defects in materials and workmanship.

For the period commencing with the date of shipment of this equipment and ending one (1) year later, MKS will, at its option, either repair or replace any part which is defective in materials or workmanship without charge to the purchaser. The foregoing shall constitute the exclusive and sole remedy of the purchaser for any breach of MKS of this warranty.

The purchaser, before returning any equipment covered by this warranty, which is asserted to be defective by the purchaser, shall make specific written arrangements with respect to the responsibility for shipping the equipment and handling any other incidental charges with the MKS Sales Representative or distributor from which the equipment was purchased or, in the case of a direct purchase from MKS, with the MKS home office in Andover, Massachusetts, USA.

This warranty does not apply to any equipment which has not been installed and used in accordance with the specifications recommended by MKS for the proper and normal use of the equipment. MKS shall not be liable under any circumstances for indirect, special, consequential, or incidental damages in connection with, or arising out of, the sale, performance, or use of the equipment covered by this warranty.

MKS recommends that all MKS pressure and flow products be calibrated periodically (typically) every 6 to 12 months) to ensure accurate readings. When a product is returned to MKS for this periodic re-calibration it is considered normal preventative maintenance not covered by any warranty.

THIS WARRANTY IS IN LIEU OF ALL OTHER RELEVANT WARRANTIES, EXPRESSED OR IMPLIED, INCLUDING THE IMPLIED WARRANTY OF MERCHANTABILITY AND THE IMPLIED WARRANTY OF FITNESS FOR A PARTICULAR PURPOSE, AND ANY WARRANTY AGAINST INFRINGEMENT OF ANY PATENT.

## 2 Safety Information

The following general safety precautions must be observed during all phases of operation of this instrument. Failure to comply with these precautions or with specific warnings elsewhere in this manual violates safety standards of intended use of the instrument and may impair the protection provided by the equipment. MKS Instruments, Inc. assumes no liability for the customer’s failure to comply with these requirements.

### DO NOT SUBSTITUTE PARTS OR MODIFY INSTRUMENT

Do not install substitute parts or perform any unauthorized modification to the instrument. Return the instrument to an MKS Calibration and Service Center for service and repair to ensure that all safety features are maintained.

### SERVICE BY QUALIFIED PERSONNEL ONLY

Operating personnel must not remove instrument covers. Component replacement and internal adjustments must be made by qualified service personnel only.

## 2.1 Symbols Used in This Instruction Manual

The following are definitions of WARNING, CAUTION, and NOTE messages used throughout the manual.

---

### **NOTE**

The **NOTE** sign denotes important information. It calls attention to a procedure, practice, condition, or the like, which is essential to highlight.

---

### **CAUTION**

The **CAUTION** sign denotes a hazard. It calls attention to an operating procedure, practice, or the like, which, if not correctly performed or adhered to, could result in damage to or destruction of all or part of the product.

---











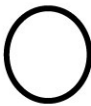

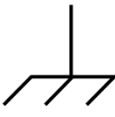
### **WARNING**

The **WARNING** sign denotes a hazard. It calls attention to a procedure, practice, condition, or the like, which, if not correctly performed or adhered to, could result in injury to personnel.

---

## 2.2 Symbols Found on the Unit

The following table describes symbols that may be found on the unit.

 ON (Supply) IEC 417, No. 5007	 OFF (Supply) IEC 417, No. 5008	 Earth (ground) IEC 417, No. 5017	 Protective Earth (ground) IEC 417, No. 5019
 Frame or Chassis IEC 417, No. 5020	 Equipotentiality IEC 417, No. 5021	 Direct Current IEC 417, No. 5031	 Alternating Current IEC 417, No. 5032
 Both Direct and Alternating Current IEC 417, No. 5033-a	 Class II Equipment IEC 417, No. 5172-a	 Three Phase Alternating Current IEC 617-2, No. 020206	
 Caution (refer to accompanying documents) ISO 3864, No. B.3.1	 Caution, Risk of Electric Shock ISO 3864, No. B.3.6	 Caution Hot Surface IEC 417, No. 5041	

### 2.3 Safety Procedures and Precautions

Observe the following general safety precautions during all phase of operation of this instrument. Failure to comply with these precautions or with specific warnings elsewhere in this manual violates safety standards of intended use of the instrument and may impair the protection provided by the equipment. MKS Instruments, Inc. assumes no liability for the customer's failure to comply with these requirements.

#### DO NOT SUBSTITUTE PARTS OR MODIFY INSTRUMENT

Do not install substitute parts or perform any unauthorized modification to the instrument. Return the instrument to an MKS Calibration and Service Center for service and repair to ensure that all safety features are maintained.

**SERVICE BY QUALIFIED PERSONNEL ONLY**

Operating personnel must not remove instrument covers. Component replacement and internal adjustments must be made by qualified service personnel only.

**KEEP AWAY FROM LIVE CIRCUITS**

Do not replace components with power cable connected. Under certain conditions, dangerous voltages may exist even with the power cable removed. To avoid injuries, always disconnect power and discharge circuits before touching them.

**USE CAUTION WHEN OPERATING WITH HAZARDOUS MATERIALS**

If hazardous materials are used, users must take responsibility to observe the proper safety precautions, completely purge the instrument when necessary, and ensure that the material used is compatible with sealing materials.

**PURGE THE INSTRUMENT**

After installing the unit, or before its removal from a system, be sure to purge the unit completely with a clean dry gas to eliminate all traces of the previously used flow material.

**USE PROPER PROCEDURES WHEN PURGING**

This instrument must be purged under a ventilation hood, and gloves must be worn to protect personnel. To purge this instrument properly, it must be purged in both the horizontal base down and horizontal base up configurations as defined in SEM spec. Device has trapped volume in pressure sensor where gas which is higher than air but still hazardous can accumulate.

**DO NOT OPERATE IN AN EXPLOSIVE ENVIRONMENT**

To avoid explosion, do not operate this product in an explosive environment unless it has been specifically certified for such operation.

**USE PROPER FITTINGS AND TIGHTENING PROCEDURES**

All instrument fittings must be consistent with instrument specifications, and compatible with the intended use of the instrument. Assemble and tighten fittings according to manufacturer's directions.

**CHECK FOR LEAK-TIGHT FITTINGS**

Before proceeding to instrument setup, carefully check all plumbing connections to the instrument to ensure leak-tight installation.

**OPERATE AT SAFE INLET PRESSURES**

This unit should never be operated at pressures higher than the rated maximum pressure (refer to the product specifications for the maximum allowable pressure).

**INSTALL A SUITABLE BURST DISC**

When operating from a pressurized gas source, a suitable burst disc should be installed in the vacuum system to prevent system explosion should the system pressure rise.

### KEEP THE UNIT FREE OF CONTAMINANTS

Do not allow contaminants of any kind to enter the unit before or during use. Contamination such as dust, dirt, lint, glass chips, and metal chips may permanently damage the unit.

### ALLOW PROPER WARM UP TIME FOR TEMPERATURE-CONTROLLED UNITS

Temperature-controlled unit will only meet specifications when sufficient time is allowed for the unit to meet, and stabilize at, the designed operating temperature. Do not zero or calibrate the unit until the warm up is complete.

## 2.4 Sicherheitshinweise für das Massenflussgerät

### 2.4.1 In dieser Betriebsanleitung vorkommende Symbole ual

Bedeutung der mit WARNUNG!, VORSICHT! und HINWEIS gekennzeichneten Absätze in dieser Betriebsanleitung.

#### HINWEIS

Das Symbol HINWEIS macht auf wichtige Informationen bezüglich eines Arbeitsablaufs, einer Arbeitsweise, eines Zustands oder einer sonstige Gegebenheit aufmerksam.

#### VORSICHT



Das Symbol VORSICHT! weist auf eine Gefahr für das Gerät hin. Es macht auf einen Bedienungsablauf, eine Arbeitsweise oder eine sonstige Gegebenheit aufmerksam, deren unsachgemäße Ausführung bzw. ungenügende Berücksichtigung zu einer Beschädigung oder Zerstörung des Gerätes oder von Teilen des Gerätes führen kann.







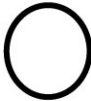

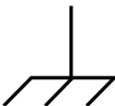

#### WARNUNG!

Das Symbol WARNUNG! weist auf eine Gefahr für das Bedienpersonal hin. Es macht auf einen Arbeitsablauf, eine Arbeitsweise, einen Zustand oder eine sonstige Gegebenheit aufmerksam, deren unsachgemäße Ausführung bzw. ungenügende Berücksichtigung zu Verletzungen führen kann.

### 2.4.2 Erklärung der am Gerät angebrachten Symbole

Nachstehender Tabelle sind die Bedeutungen der Symbole zu entnehmen, die am Gerät angebracht sein können.

			
Ein (Energie) IEC 417, No.5007	Aus (Energie) IEC 417, No.5008	Erdanschluss IEC 417, No.5017	Schutzleiteranschluss IEC 417, No.5019

 <p>Masseanschluss IEC 417, No.5020</p>	 <p>Aquipotentialanschluss IEC 417, No. 5021</p>	 <p>Gleichstrom IEC 417, No.5031</p>	 <p>Wechselstrom IEC 417, No.5032</p>
 <p>Gleich- oder Wechselstrom IEC 417, No.5033-a</p>	 <p>Durchgängige doppelte oder verstärkte Isolierung IEC 417, No.5172-a</p>	 <p>Dreileiter-Wechselstrom (Drehstrom) IEC 617-2, No.020206</p>	
 <p>Warnung vor einer Gefahrenstelle (Achtung, Dokumentation beachten) ISO 3864, No.B.3.1</p>	 <p>Warnung vor gefährlicher elektrischer Spannung ISO 3864, No.B.3.6</p>	 <p>Höhere Temperatur an leicht zugänglichen Teilen IEC 417, No.5041</p>	

### 2.4.3 Sicherheitsvorschriften und Vorsichtsmaßnahmen

Folgende allgemeine Sicherheitsvorschriften sind während allen Betriebsphasen dieses Gerätes zu befolgen. Eine Missachtung der Sicherheitsvorschriften und sonstiger Warnhinweise in dieser Betriebsanleitung verletzt die für dieses Gerät und seine Bedienung geltenden Sicherheitsstandards, und kann die Schutzvorrichtungen an diesem Gerät wirkungslos machen. MKS Instruments, Inc. haftet nicht für Missachtung dieser Sicherheitsvorschriften seitens des Kunden.

#### **NIEMALS TEILE AUSTAUSCHEN ODER ÄNDERUNGEN AM GERÄT VORNEHMEN!**

Ersetzen Sie keine Teile mit baugleichen oder ähnlichen Teilen, und nehmen Sie keine eigenmächtigen Änderungen am Gerät vor. Schicken Sie das Gerät zwecks Wartung und Reparatur an den MKS- Kalibrierungs- und -Kundendienst ein. Nur so wird sichergestellt, dass alle Schutzvorrichtungen voll funktionsfähig bleiben.

#### **WARTUNG NUR DURCH QUALIFIZIERTE FACHLEUTE!**

Das Auswechseln von Komponenten und das Vornehmen von internen Einstellungen darf nur von qualifizierten Fachleuten durchgeführt werden, niemals vom Bedienpersonal.

#### **VORSICHT VOR STROMFÜHRENDEN LEITUNGEN!**

Ersetzen Sie keine Komponente von Geräten, die an Netzstrom angeschlossen sind. Unter Umständen kann gefährliche Spannung auch dann bestehen, wenn das Netzanschlusskabel von der

Stromversorgung entfernt wurde. Um Verletzungen vorzubeugen sollten zuerst alle Geräte von der Stromversorgung getrennt und alle Stromkreisläufe entladen werden.

### **VORSICHT BEIM ARBEITEN MIT GEFÄHRLICHEN STOFFEN!**

Wenn gefährliche Stoffe verwendet werden, muss der Bediener die entsprechenden Sicherheitsvorschriften genauestens einhalten, das Gerät, falls erforderlich, vollständig spülen, sowie sicherstellen, dass der Gefahrstoff die am Gerät verwendeten Materialien, insbesondere Dichtungen, nicht angreift.

### **SPÜLEN DES GERÄTES MIT GAS!**

Nach dem Installieren oder vor dem Ausbau aus einem System muss das Gerät unter Einsatz eines reinen Trockengases vollständig gespült werden, um alle Rückstände des Vorgängermediums zu entfernen.

### **ANWEISUNGEN ZUM SPÜLEN DES GERÄTES**

Das Gerät darf nur unter einer Ablufthaube gespült werden. Schutzhandschuhe sind zu tragen.

### **GERÄT NICHT ZUSAMMEN MIT EXPLOSIVEN STOFFEN, GASEN ODER DÄMPFEN BENUTZEN!**

Um der Gefahr einer Explosion vorzubeugen, darf dieses Gerät niemals zusammen mit (oder in der Nähe von) explosiven Stoffen aller Art eingesetzt werden, sofern es nicht ausdrücklich für diesen Zweck zugelassen ist.

### **ANWEISUNGEN ZUM INSTALLIEREN DER ARMATUREN!**

Alle Anschlussstücke und Armaturenteile müssen mit der Gerätespezifikation übereinstimmen, und mit dem geplanten Einsatz des Gerätes kompatibel sein. Der Einbau, insbesondere das Anziehen und Abdichten, muss gemäß den Anweisungen des Herstellers vorgenommen werden.

### **VERBINDUNGEN AUF UNDICHTIGKEITEN PRÜFEN!**

Überprüfen Sie sorgfältig alle Verbindungen der Vakuumkomponenten auf undichte Stellen.

### **GERÄT NUR UNTER ZULÄSSIGEN ANSCHLUSSDRÜCKEN BETREIBEN!**

Betreiben Sie das Gerät niemals unter Drücken, die den maximal zulässigen Druck (siehe Produktspezifikationen) übersteigen.

### **GEEIGNETE BERSTSCHEIBE INSTALLIEREN!**

Wenn mit einer unter Druck stehenden Gasquelle gearbeitet wird, sollte eine geeignete Berstscheibe in das Vakuumsystem installiert werden, um eine Explosionsgefahr aufgrund von steigendem Systemdruck zu vermeiden.

### **VERUNREINIGUNGEN IM GERÄT VERMEIDEN!**

Stellen Sie sicher, dass Verunreinigungen jeglicher Art weder vor dem Einsatz noch während des Betriebs in das Instrumenteninnere gelangen können. Staub- und Schmutzpartikel, Glassplitter oder Metallspäne können das Gerät dauerhaft beschädigen oder Prozess- und Messwerte verfälschen.

### BEI GERÄTEN MIT TEMPERATURKONTROLLE KORREKTE ANWÄRMZEIT EINHALTEN!

Temperaturkontrollierte Geräte arbeiten nur dann gemäß ihrer Spezifikation, wenn genügend Zeit zum Erreichen und Stabilisieren der Betriebstemperatur eingeräumt wird. Kalibrierungen und Nulleinstellungen sollten daher nur nach Abschluss des Anwärmvorgangs durchgeführt werden.

## 2.5 Informations de sécurité pour appareils de mesure/contrôle de débit massique

### 2.5.1 Symboles utilisés dans ce manuel d'utilisation

Définitions des indications AVERTISSEMENT, ATTENTION, et REMARQUE utilisées dans ce manuel.

#### REMARQUE

L'indication REMARQUE signale une information importante. Elle attire l'attention sur une procédure, une pratique, une condition, ou toute autre situation, présentant un intérêt particulier.

#### ATTENTION





L'indication ATTENTION signale un danger pour l'appareil. Elle attire l'attention sur une procédure d'exploitation, une pratique, ou toute autre situation, présentant un risque de dégât ou de destruction partielle ou totale du produit, en cas d'exécution incorrecte ou de non-respect des consignes.

#### AVERTISSEMENT







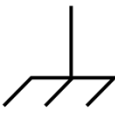

L'indication AVERTISSEMENT signale un danger pour le personnel. Elle attire l'attention sur une procédure, une pratique, une condition, ou toute autre situation présentant un risque d'accident pour le personnel, en cas d'exécution incorrecte ou de non-respect des consignes.

### 2.5.2 Symboles figurant sur l'unité

Le tableau suivant décrit les symboles pouvant apparaître sur l'unité.

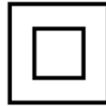
			
Marche (sous tension) IEC 417, No.5007	Arrêt (hors tension) IEC 417, No.5008	Terre (masse) IEC 417, No.5017	Terre de protection (masse) IEC 417, No.5019



 Masse IEC 417, No.5020	 equipotentialité IEC 417, No.5021	 Courant continu IEC 417, No.5031	 Courant alternatif IEC 417, No.5032
 Courant continu et alternatif IEC 417, No.5033-a	 Matériel de classe II IEC 417, No.5172-a	 Courant alternatif triphasé IEC 617-2, No.020206	
 Attention : se reporter à la documentation ISO 3864, No.B.3.1	 Attention : risque de choc électrique ISO 3864, No.B.3.6	 Attention : surface brûlante IEC 417, No.5041	

### 2.5.3 Mesures de sécurité et précautions

Observer les précautions générales de sécurité suivantes pendant toutes les phases d'exploitation de cet appareil. Le non-respect de ces précautions ou des avertissements du manuel constitue une violation des normes de sécurité relatives à l'utilisation de l'appareil et peut compromettre la protection assurée par l'appareil. MKS Instruments, Inc. rejette toute responsabilité en cas de non-respect des consignes par les clients.

#### PAS DE REMPLACEMENT DE PIÈCES OU DE MODIFICATION DE L'APPAREIL

Ne pas installer de pièces de remplacement ni effectuer des modifications non autorisées sur l'appareil. Renvoyer l'appareil à un centre de service et de calibrage MKS pour tout dépannage ou réparation afin de garantir l'intégrité des dispositifs de sécurité.

#### DÉPANNAGE UNIQUEMENT PAR DU PERSONNEL QUALIFIÉ

Le personnel d'exploitation ne doit pas essayer de sortir les composants du boîtier ou faire des réglages internes. Le dépannage est réservé au personnel qualifié.

#### ÉLOIGNEMENT DES CIRCUITS SOUS-TENSION

Ne pas remplacer de composants lorsqu'un câble d'alimentation est branché. Dans certaines conditions, des tensions dangereuses peuvent être présentes même après le retrait du câble d'alimentation. Pour éliminer tout risque de blessure, procéder toujours à la déconnexion et décharger les circuits avant tout contact physique.

### **PRÉCAUTION EN CAS D'UTILISATION AVEC DES PRODUITS DANGEREUX**

Si des produits dangereux sont utilisés, l'utilisateur est responsable du respect des mesures de sécurité appropriées, de la purge complète de l'appareil quand elle s'avère nécessaire, et doit s'assurer que les produits utilisés sont compatibles avec les matériaux d'étanchéité.

### **PURGE DE L'APPAREIL**

Après l'installation de l'unité, ou avant son retrait d'un système, purger l'unité complètement avec un gaz propre et sec afin d'éliminer toute trace du produit de flux utilisé précédemment.

### **UTILISATION DES PROCÉDURES APPROPRIÉES POUR LA PURGE**

Cet appareil doit être purgé sous une hotte de ventilation. Le personnel doit porter des gants de protection.

### **PAS D'EXPLOITATION DANS UN ENVIRONNEMENT EXPLOSIF**

Pour éviter toute explosion, ne pas utiliser cet appareil dans un environnement explosif, sauf en cas d'homologation spécifique pour une telle exploitation.

### **UTILISATION D'ÉQUIPEMENTS ET PROCÉDURES DE SERRAGE APPROPRIÉS**

Tous les équipements de l'appareil doivent être conformes à ses spécifications, et compatibles avec l'utilisation prévue de l'appareil. Assembler et serrer les équipements conformément aux directives du fabricant.

### **VÉRIFICATION DE L'ÉTANCHÉITÉ DES CONNEXIONS**

Vérifier attentivement toutes les connexions des composants pour le vide afin de garantir l'étanchéité de l'installation.

### **EXPLOITATION AVEC DES PRESSIONS D'ENTRÉE NON DANGEREUSES**

Ne jamais utiliser des pressions supérieures à la pression nominale maximum (se reporter aux spécifications de l'unité pour la pression maximum admissible).

### **INSTALLATION D'UN DISQUE D'ÉCHAPPEMENT ADAPTÉ**

En cas d'exploitation avec une source de gaz pressurisé, installer un disque d'échappement adapté dans le système à vide, afin d'éviter une explosion du système en cas d'augmentation de la pression.

### **MAINTIEN DE L'UNITÉ À L'ABRI DES CONTAMINATIONS**

Ne pas laisser des produits contaminants pénétrer dans l'unité avant ou pendant l'utilisation. Des produits contaminants tels que des poussières et des fragments de tissu, de verre et de métal peuvent endommager l'unité de manière permanente.

### **RESPECT DU TEMPS D'ÉCHAUFFEMENT APPROPRIÉ POUR LES UNITÉS À RÉGULATION DE TEMPÉRATURE**

Les unités à régulation de température sont conformes à leurs spécifications uniquement quand on leur laisse un temps suffisant pour atteindre d'une manière stable la température d'exploitation. Ne pas remettre à zéro ou calibrer l'unité tant que l'échauffement n'est pas terminé.

## 2.6 Medidas de seguridad del dispositivo de flujo de masa

### 2.6.1 Símbolos usados en este manual de instrucciones

Definiciones de los mensajes de advertencia, precaución y de las notas usados en el manual.

#### **NOTA**

El símbolo de notas indica información de importancia. Este símbolo pone de relieve un procedimiento, práctica o condición cuyo conocimiento es esencial destacar.

#### **PRECAUCIÓN**





El símbolo de precaución indica la posibilidad de producir daños al equipo. Pone de relieve un procedimiento operativo, práctica, etc. que en caso de no realizarse o cumplirse correctamente puede causar daños o la destrucción total o parcial del equipo.



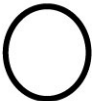

#### **ADVERTENCIA**

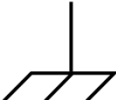
El símbolo de advertencia indica la posibilidad de que se produzcan daños personales. Pone de relieve un procedimiento, práctica, estado, etc. que en caso de no realizarse o cumplirse correctamente puede causar daños personales.

### 2.6.2 Símbolos hallados en la unidad

La tabla siguiente contiene los símbolos que puede hallar en la unidad.

 <p>Encendido (alimentación eléctrica) IEC 417, N° 5007</p>	 <p>Apagado (alimentación eléctrica) IEC 417, N° 5008</p>	 <p>Puesta a tierra IEC 417, N° 5017</p>	 <p>Protección a tierra IEC 417, N° 5019</p>
 <p>Caja o chasis IEC 417, N° 5020</p>	 <p>Equipotencialidad IEC 417, N° 5021</p>	 <p>Corriente continua IEC 417, N° 5031</p>	 <p>Corriente alterna IEC 417, N° 5032</p>

 <p>Corriente continua y alterna IEC 417, N° 5033-a</p>	 <p>Equipo de clase II IEC 417, N° 5172-a</p>	 <p>Corriente alterna trifásica IEC 617-2, N° 020206</p>
 <p>Precaución. Consulte los documentos adjuntos ISO 3864, N° B.3.1</p>	 <p>Precaución. Riesgo de descarga eléctrica ISO 3864, N° B.3.6</p>	 <p>Precaución. Superficie caliente IEC 417, N° 5041</p>

### 2.6.3 Procedimientos y precauciones de seguridad

Las medidas generales de seguridad descritas a continuación deben observarse durante todas las etapas de funcionamiento del instrumento. La falta de cumplimiento de dichas medidas de seguridad o de las advertencias específicas a las que se hace referencia en otras partes de este manual, constituye una violación de las normas de seguridad establecidas para el uso previsto del instrumento y podría anular la protección proporcionada por el equipo. Si el cliente no cumple dichas precauciones y advertencias, MKS Instruments, Inc. no asume responsabilidad legal alguna.

#### NO UTILICE PIEZAS NO ORIGINALES O MODIFIQUE EL INSTRUMENTO

No instale piezas que no sean originales ni modifique el instrumento sin autorización. Para asegurar el correcto funcionamiento de todos los dispositivos de seguridad, envíe el instrumento al Centro de servicio y calibración de MKS toda vez que sea necesario repararlo o efectuar tareas de mantenimiento.

#### LAS REPARACIONES DEBEN SER EFECTUADAS ÚNICAMENTE POR TÉCNICOS AUTORIZADOS

Los operarios no deben retirar las tapas del instrumento. El reemplazo de los componentes y las tareas de ajuste deben ser realizadas únicamente por personal autorizado.

#### MANTÉNGASE ALEJADO DE LOS CIRCUITOS ACTIVOS

No reemplace componentes con el cable de alimentación eléctrica conectado. En algunos casos, puede haber presente alto voltaje aun con el cable de alimentación eléctrica desconectado. Para evitar lesiones personales, desconecte siempre el cable y descargue los circuitos antes de entrar en contacto con los mismos.

#### TENGA CUIDADO CUANDO TRABAJE CON MATERIALES TÓXICOS

Cuando se utilicen materiales tóxicos, es responsabilidad de los operarios tomar las medidas de seguridad correspondientes, purgar totalmente el instrumento cuando sea necesario y comprobar que el material utilizado sea compatible con los materiales de sellado.

### **PURGUE EL INSTRUMENTO**

Una vez instalada la unidad o antes de retirarla del sistema, purgue completamente la unidad con gas limpio y seco para eliminar todo resto de la sustancia líquida empleada anteriormente.

### **USE PROCEDIMIENTOS ADECUADOS PARA REALIZAR LA PURGA**

El instrumento debe purgarse debajo de una campana de ventilación y deben utilizarse guantes protectores.

### **NO HAGA FUNCIONAR EL INSTRUMENTO EN AMBIENTES CON RIESGO DE EXPLOSIÓN**

Para evitar que se produzcan explosiones, no haga funcionar este instrumento en un ambiente con riesgo de explosiones, excepto cuando el mismo haya sido certificado específicamente para tal uso.

### **USE ACCESORIOS ADECUADOS Y REALICE CORRECTAMENTE LOS PROCEDIMIENTOS DE AJUSTE**

Todos los accesorios del instrumento deben cumplir las especificaciones del mismo y ser compatibles con el uso que se debe dar al instrumento. Arme y ajuste los accesorios de acuerdo con las instrucciones del fabricante.

### **COMPRUEBE QUE LOS ACCESORIOS SEAN A PRUEBA DE FUGAS**

Antes de proceder con la instalación del instrumento, inspeccione cuidadosamente todas las conexiones de las tuberías para comprobar que hayan sido instaladas a prueba de fugas.

### **HAGA FUNCIONAR EL INSTRUMENTO CON PRESIONES DE ENTRADA SEGURAS**

No haga funcionar nunca el instrumento con presiones superiores a la máxima presión nominal (en las especificaciones del instrumento hallará la presión máxima permitida).

### **INSTALE UNA CÁPSULA DE SEGURIDAD ADECUADA**

Cuando el instrumento funcione con una fuente de gas presurizado, instale una cápsula de seguridad adecuada en el sistema de vacío para evitar que se produzcan explosiones cuando suba la presión del sistema.

### **MANTENGA LA UNIDAD LIBRE DE CONTAMINANTES**

No permita el ingreso de contaminantes en la unidad antes o durante su uso. Los productos contaminantes tales como polvo, suciedad, pelusa, lascas de vidrio o virutas de metal pueden dañar irreparablemente la unidad.

### **CALIENTE ADECUADAMENTE LAS UNIDADES CONTROLADAS POR MEDIO DE TEMPERATURA**

Las unidades controladas por medio de temperatura funcionarán de acuerdo con las especificaciones sólo cuando se las caliente durante el tiempo suficiente para permitir que lleguen y se establezcan a la temperatura de operación indicada. No calibre la unidad y no la ponga en cero hasta que finalice el procedimiento de calentamiento.

## 2.7 マスフロー機器の安全に関する情報

### 2.7.1 この取扱説明書で使用されているシンボル

本マニュアルでは警告、注意、ポイントのマークを用いて重要な事項を記載しています。

#### ポイント

この表示は手順や使用方法、条件などに関する重要な情報が記載されていることを示しています。必ずお読みください。

#### 注意











この表示を無視して誤った取り扱い(手順や使用方法など)をすると、製品が損傷する可能性が想定される内容を示しています。必ずお読みください。

#### 警告

この表示を無視して誤った取り扱い(手順や使用方法、条件など)をすると、人が重傷を負う可能性が想定される内容を示しています。必ずお読みください。

### 2.7.2 本機器のマーク

以下の表では、本機器に使用されているマークについて説明いたします。

 オン(電源) IEC 417, No. 5007	 オフ(電源) IEC 417, No. 5008	 接地(アース) IEC 417, No. 5017	 保護接地(アース) IEC 417, No. 5019
 フレームまたはシャーシ IEC 417, No. 5020	 等電位 IEC 417, No. 5021	 直流 IEC 417, No. 5031	 交流 IEC 417, No. 5032
 直流と交流 IEC 417, No. 5033-a	 クラス 2 機器 IEC 417, No. 5172-a	 三相交流 IEC 617-2, No. 020206	



注意 (付属書を参照)  
ISO 3864, No. B.3.1



注意 (感電の危険あり)  
ISO 3864, No. B.3.6



注意 (表面が熱くなっています)  
IEC 417, No. 5041

### 2.7.3 安全対策について

本機器を使用する際は、必ず以下の安全対策を守ってください。これらの安全対策や本マニュアルの警告を無視すると、機器本来の用途の安全基準を侵害することになり、機器が提供する保護機能が損なわれる可能性があります。MKS Instruments, Inc. は、顧客側の安全対策の不履行に対しては一切責任を負いかねます。

#### 勝手に部品を変えたり、本体を改造しないこと

本機器に代用部品を使用したり、不正な改造を加えないでください。すべての安全システムを正しく機能させるための修理やメンテナンスが必要な場合は、本機器を MKS Calibration and Service Center まで戻してください。

#### 修理は必ず専門の修理サービスを利用すること

オペレータは絶対に本機器を分解しないでください。部品の交換や内部の調整は必ず専門の修理サービスを利用してください。

#### 電流が通じている回路から切断すること

電源ケーブルを接続したままで部品を交換しないでください。特定の状況では、電源ケーブルを取り外した状態でも危険な電圧が残っている場合があります。感電などの事故を防ぐため、回路に触れる前に必ず電源から切断し、放電してください。

#### 危険な材料を使用する場合は慎重に機器を使用すること

危険な材料を使用する場合は、使用者は各自の責任の元で適切な安全対策を講じてください。必要に応じて本機器を浄化してください。また、使用する材料に対するシーリング材の耐久性を確認してください。

#### 機器を浄化すること

本機器を取り付けた後やシステムから取り外す前に、きれいな乾燥ガスで本機器を浄化し、使用した材料を完全に除去してください。

### 浄化する場合は適切な手順で行うこと

本機器の浄化は換気フードの下で行う必要があります。また、浄化作業を行う人は必ず手袋を着用してください。

### 爆発の危険性のある環境で機器を使用しないこと

爆発が起きるのを防ぐため、本機器を爆発の危険性のある環境で使用しないでください。ただし、そのような環境での使用が特別に保証されている場合は除きます。

### 適切な金具類を使用し、手順に従って金具の締めを行うこと

金具類は本機器の仕様と一致し、機器本来の用途に適したものである必要があります。金具類の取り付けや締めは、製造業者の指示に従ってください。

### 液体の漏れがないよう接続箇所を確認すること

本機器を設定する前に、すべての配管の接続を慎重に確認し、液体が漏れないようにしてください。マスフロー機器の安全に関する情報

### 安全なインレット圧力で使用すること

定格の最大圧力を超える圧力の下で本機器を絶対に使用しないでください (最大許容圧力については仕様書を参照)。

### 適切なバーストディスクを取り付けること

圧力のかかったガスを使用する場合は、万一システムが爆発した場合にシステムの圧力が上昇するのを防ぐため、真空システムに適切なバーストディスクを取り付けてください。

### 本機器に異物やゴミが混入しないようにすること

本機器の使用前または使用中に、ほこりやゴミ、繊維、ガラスの破片、金属片などの異物やゴミが混入しないようにしてください。本機器が損傷する可能性があります。

### 温度調整された機器を十分に温めてから使用すること

温度調整された機器が適切な作動温度にならないうちに使用すると、仕様通りの動作をしないことがあります。本機器が十分に温まるまでは目盛りをゼロに合わせたり、較正しないでください



## 2.8 질량 유량 장치 안전 정보

### 2.8.1 본 지침 매뉴얼에 사용되는 기호들

매뉴얼 전체에 사용되는 경고, 주의 및 참고 메시지의 정의.

#### 참고

この表示は手順や使用方法、条件などに関する重要な情報が記載されていることを示しています。必ずお読みください。

#### 注意







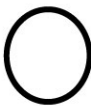

この表示を無視して誤った取り扱い(手順や使用方法など)をすると、製品が損傷する可能性が想定される内容を示しています。必ずお読みください。

#### 경고

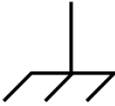
경고 표시는 위험을 나타냅니다. 이 표시는 올바르게 수행되거나 지켜지지 않을 경우, 사람에게 상해를 입힐 수 있는 절차, 수행지침, 상태 또는 이와 유사한 상황들에 대한 주의를 환기시킵니다.

### 2.8.2 장치에 표시된 기호들

다음 표는 장치에서 볼 수 있는 기호들을 설명합니다.

 켄 (전원) IEC 417, No. 5007	 곰 (전원) IEC 417, No. 5008	 접지(지면) IEC 417, No. 5017	 보호 접지(지면) IEC 417, No. 5019
 프레임 또는 새시 IEC 417, No. 5020	 등전위성 IEC 417, No. 5021	 직류 IEC 417, No. 5031	 교류 IEC 417, No. 5032
 직류와 교류 모두 IEC 417, No. 5033-a	 클래스 II 장비 IEC 417, No. 5172-a	 3상 교류 IEC 617-2, No. 020206	



주의 (동봉 문서 참조)  
ISO 3864, No. B.3.1



주의, 감전 위험  
ISO 3864, No. B.3.6



주의, 표면이 뜨거움  
IEC 417, No. 5041

### 2.8.3 안전 절차 및 예방조치

본 기계의 모든 작동 시에 다음의 일반 안전 예방조치를 준수하십시오. 아래 예방조치를 준수하지 않거나 본 매뉴얼의 다른 부분에 있는 특정 경고를 준수하지 않을 경우, 기계 사용 목적의 안전 기준을 위반하는 것이 되며, 장비가 제공하는 보호기능을 손상시킬 수 있습니다. MKS Instruments, Inc.는 고객이 본 요건을 준수하지 않는 경우에 대해서는 어떠한 책임도 지지 않습니다.

#### 부품을 교체하거나 기계를 개조하지 마십시오

교체 부품을 설치하거나 기계에 허가되지 않은 어떠한 수정도 가하지 마십시오. 서비스와 수리가 필요한 경우에는 모든 안전 특성이 유지되도록 기계를 MKS 보정 서비스 센터(MKS Calibration and Service Center)로 보내주십시오.

#### 자격이 있는 사람에게만 서비스를 받으십시오

작동하는 사람은 기계 겉면을 제거해서는 안됩니다. 부품 교체 및 내부 조정은 자격이 있는 서비스 기사에게만 받으실 수 있습니다.

#### 전류가 통하는 회로에서 분리해 보관하십시오

전원 케이블을 연결한 채로 부품을 교체하지 마십시오. 일부 환경에서는 전원 케이블을 제거한 상태라도 위험 전압이 존재할 수 있습니다. 부상을 방지하려면, 전원을 항상 분리하고 회로를 만지기 전에 회로를 방전시키십시오.

#### 위험한 물질과 함께 작동할 때는 주의를 기울이십시오

위험한 물질이 사용되는 경우, 사용자는 필요시 기계를 완전히 청소하여, 적절한 안전 예방조치를 준수할 책임을 지키고, 사용된 물질이 봉인 물질과 함께 사용해도 무방하다고 보증할 수 있어야 합니다.

### 기계를 청소하십시오

장치를 설치한 후나 시스템에서 장치를 제거하기 전에는 반드시 깨끗한 건조성 기체로 장치를 완전히 청소하여 이전에 사용된 유량 물질의 모든 흔적을 제거하십시오.

### 청소 시에는 적절한 절차를 사용하십시오

본 기계는 환기 후드 아래에서 청소되어야 하며, 인체 보호를 위해 장갑을 착용해야 합니다.

### 폭발성 환경에서 작동하지 마십시오

폭발을 방지하려면, 폭발성 환경에서 작동하도록 특별히 승인받지 않은 경우 본 제품을 폭발성 환경에서 작동하지 마십시오.

### 적절한 조립부품과 조임 절차를 사용하십시오

모든 기계 조립부품은 제품 사양과 일치해야 하고, 기계의 사용 목적에 부합해야 합니다. 제조업체의 지시에 따라 조립부품을 조립하고 조이십시오.

### 누출방지 조립부품을 점검하십시오

기계 설치를 진행하기 전에 기계의 모든 연관 연결부를 점검해 누출방지 설치가 되었는지 확인하십시오.

### 안전한 흡입 압력에서 작동하십시오

이 장치는 절대 정격 최대 압력보다 높은 압력에서 작동해서는 안 됩니다(최대 허용 압력에 대해서는 제품 사양을 참조하십시오).

### 적합한 안전 파열판을 설치하십시오

가압 가스 공급원에서 작동시, 시스템 폭발이 시스템 압력 상승을 일으키는 것을 방지하기 위해 적합한 안전 파열판이 진공 시스템에 설치되어야 합니다.

### 장치를 오염이 없는 곳에 보관하십시오

장치를 사용하기 전이나 사용 중에는 어떠한 종류의 오염 물질도 허용해서는 안 됩니다. 먼지, 때, 보풀, 유리 조각, 금속 조각과 같은 오염 물질은 영구적으로 장치를 손상시킬 수 있습니다.

**온도 제어 장치의 경우 알맞은 시동 시간을 두십시오**

온도 제어 장치는 장치가 설계 작동 온도와 일치하고 이 온도에서 안정화될 수 있도록 충분한 시간을 허용해야만 사양에 맞게 작동합니다. 시동이 완료될 때까지 장치를 영점 설정하거나 보정하지 마십시오.

### 3 Overview

Performance from chamber to chamber has historically varied due to the typical operating errors of commercially available mass flow controllers (MFCs) provided by different suppliers who calibrate them with surrogate gases traceable to different primary standards. While chamber pressure rate of rise techniques have been used to check performance of installed MFCs, there are limits to the accuracy of the technique.

Specifically, the measurement accuracy can be limited by tough to control ambient temperature variations, by pressure sensor ranges which do not provide enough resolution to achieve accurate mass flow predictions, and chamber volumes which require large gas consumption or lengthy measurement times to achieve measurable pressure changes.

Recent advances in process tool design have relied on 2nd generation mass flow verifiers which can provide quick, in-situ verification of MFC output using the same pressure rate of rise technique previously available only through in-chamber measurements. While significantly improving overall process performance on a single tool, existing mass flow verifiers have had more moderate success in reducing tool to tool variation associated with typical design and installation variations, i.e. the external volume problem.

MKS Instruments HA-MFV design represents a significant step in in-situ mass flow verification technology by incorporating sonic nozzle technology to eliminate potential verification errors due external volume effects. The MKS high accuracy MFV is designed for installation on the process tool to verify the mass flow controller flow rate in-situ. The HA-MFV's 1.0% of reading measurement accuracy gives the user the ability to verify the MFC's flow with the actual process gas to a degree significantly better than previous rate-of-rise devices or the process chamber rate-of rise method.



Figure 1: High Accuracy Mass Flow Verifier - HAMFV

### 3.1 Product Support Documents

Product support documents and additional detailed information about various I/O specifications can be found on the MKS web site for the PPCM. These documents include:

- HA-MFV data sheet
- Quick start guides to establish communication to the device over Ethernet for HA-MFV configuration
- Step files
- DeviceNet specification
- Ethercat specification

### 3.2 Manual References

The documents listed below are referenced throughout this manual.

- [1] DeviceNet Specification, Volume I: DeviceNet Communication Model and Protocol, Open DeviceNet Vendors Association, Inc. Release 2.0. ERRATA 4.0
- [2] DeviceNet Specification, Volume II: DeviceNet Profiles and Object Library, Open DeviceNet Vendors Association, Inc. Release 2.0. ERRATA 4.0
- [3] EtherCAT Semiconductor Device Profile - ETG.5003.20XX V 0.0.2
- [4] Sensor/Actuator Network Common Device Model, SEMI Standards Document E54.1-0097.
- [5] Sensor/Actuator Network Communications Standard for DeviceNet, SEMI Standards Draft Document E54.4-0097.
- [6] SEMI Standards Document E52-95. Practice for Referencing Gases and Gas Mixtures Used in Digital Mass Flow Controllers
- [7] DeviceNet Supplement – Document # 20041005-001
- [8] Ethercat Supplement – Document # 20041006-001

### 3.3 Rate of Rise Mass Flow Verification

A typical rate-of-rise mass flow verifier (MFV) contains a volume element (chamber), a pressure transducer, a temperature sensor, and two isolation valves on the inlet and outlet from the chamber respectively. The basic principle of mass flow verification is a mass balance over the chamber:

$$\frac{dn_{in}}{dt} - \frac{dn_{out}}{dt} = \frac{dn_c}{dt}$$

where  $n_c$  is the total number of molecules in the chamber,  $n_{in}$  the total number of incoming molecules, and  $n_{out}$  the total number of outgoing molecules.

The ideal gas law is applied to the gas in the chamber as:

$$n_c = \frac{PV_c}{RT}$$

where  $P$  is the chamber gas pressure,  $V_c$  is the chamber volume,  $R$  is the gas constant, and  $T$  the gas temperature. The above equation can be simplified to:

$$Q_{in} = k \frac{T_{sp} V_c}{P_{sp}} \frac{d}{dt} \left( \frac{P}{T} \right)$$

Therefore the inlet gas flow rate can be calculated by measuring the gas pressure and the gas temperature in the chamber of the mass flow verifier. A typical mass flow verification procedure is as follows:

1. open both the upstream and the downstream valves;
2. give a flow set point for the test MFC;
3. wait until the chamber pressure is at steady state;
4. record the chamber pressure and the chamber wall temperature;
5. shut the downstream valve and record the rate of chamber pressure rise;
6. open the downstream valve;
7. report the calculated flow based on the equations presented above.

A typical mass flow verifier with the design presented above requires knowledge not only of the chamber volume but also the volume between the chamber and the upstream valve (external volume) as pressure is rising in both volumes during the measurement. As the ratio of the external volume to the chamber volume increases, the accuracy of the mass flow rate calculation decreases.

### 3.4 HA-MFV Design and Operation

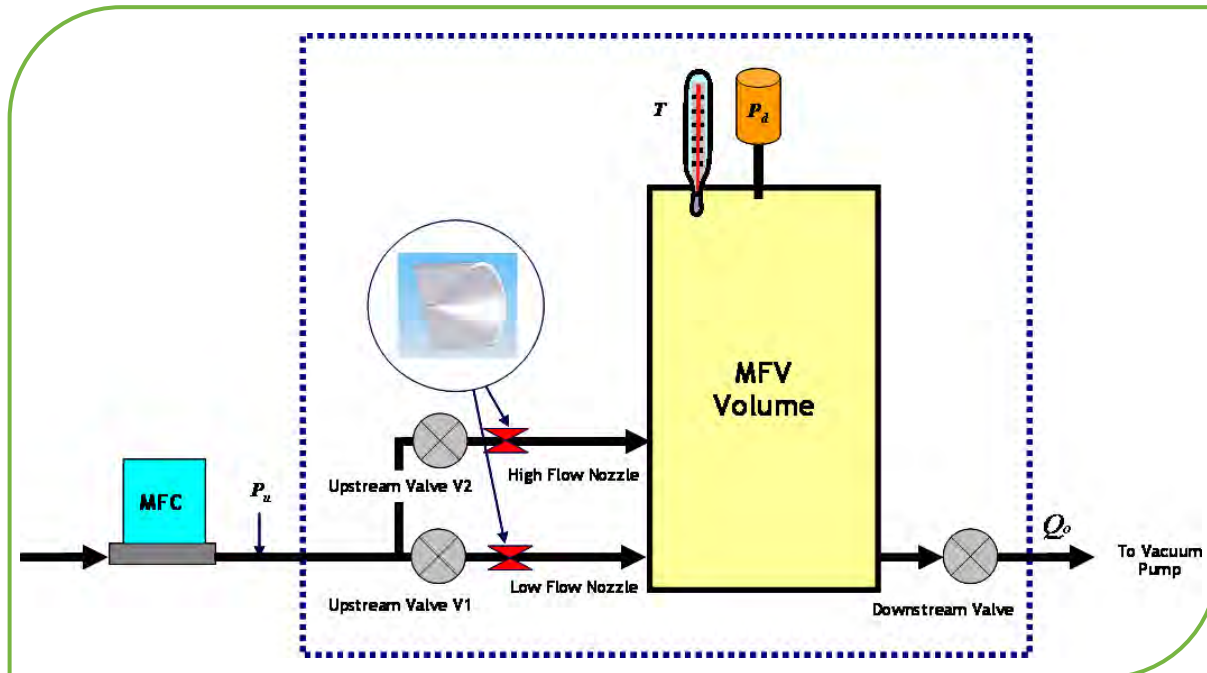

Figure 2: HA-MFV Functional Block Diagram

The MKS HA-MFV Mass Flow Verifier has been designed with nozzle (s) between the chamber and the upstream valve as illustrated in Figure 2 creating a significant pressure drop and sonic flow conditions across the nozzle. In sonic flow, variations in downstream pressure are not felt upstream of the nozzle.

As long as the ratio of the chamber pressure to the upstream pressure is less than the critical pressure ratio for the gas, the rising chamber pressure will not affect the pressure at the inlet of the mass flow verifier and therefore not affect the performance of the MFC being verified. Because the upstream pressure is constant during the entire measurement process, the MKS HA-MFV is insensitive to variations in external volume (i.e. the volume between the MFC and the nozzle). The external volume is irrelevant to the flow verification calculation.

## 3.5 HAMFV Product Features

### 3.5.1 Sonic Nozzles

The MKS HA-MFV Mass Flow Verifier incorporates two precision machined sonic nozzles in its inlet section which are used to establish the sonic flow conditions for the process gas regardless of flow rate. A large nozzle is used for high flow rates and heavy process gases while a smaller nozzle is used for low flow rates and lighter process gases. The HA-MFV determines which nozzle to use for establishing the proper gas flow conditions based on the process gas and approximate flow rate expected. The nozzles can be sized as needed for particular applications and, because they are not



actually used for calculation of the mass flow rate, are not subject to the calibration drift associated with pressure based venturi flow meters. The nozzles allow operation of the mass flow verifier with light gases (such as helium and hydrogen) across a range from 3 sccm to 3000 sccm N<sub>2</sub> equivalent flow provided proper pumping speed and downstream conductance are maintained. Standard nozzles are sized for approximately 150 T upstream pressure at 3000 sccm N<sub>2</sub> flow.

### 3.5.2 Capacitance Manometer

The MKS HA-MFV Mass Flow Verifier incorporates a patented high-accuracy 600-series absolute capacitance manometer with a 100 T full scale pressure range. The unheated analog sensor provides very fast response with minimal hysteresis and the very high resolution necessary to make measurements of low flow rates within a reasonable amount of time. It has demonstrated excellent repeatability and stability in independent tests, making it the transducer of choice for many chamber designs. Its Inconel and Incoloy nickel alloy construction allow it to operate without damage in aggressive process gas chemistries including halogens, ozone, and deionized water vapor. The sensor can withstand repeated exposures to 45 psia without permanent degradation or shift of measurement output allowing it to tolerate occasional system mishaps while ensuring reliable operation.

### 3.5.3 RTD's

The MKS HA-MFV Mass Flow Verifier uses multiple high-accuracy precision calibrated 1000 ohm four-wire RTD sensors to measure the effects of both process gas and ambient temperature variation. The NIST traceable RTD's are ruggedly packaged and securely fastened to the internal volume. The secure mounting system allows the device to withstand harsh vibration conditions encountered during installation and / or shipment. The RTD's are accurate to within +/- 1.0 °C.

### 3.5.4 Volume and Manifolds

The volume and manifolds are manufactured from 316L passivated stainless steel. Volume has a 150 psig burst pressure rating and 45 psia proof pressure.

### 3.5.5 Isolation Valves

The MKS HA-MFV Mass Flow Verifier uses ultra high purity (UHP) normally closed, pneumatic isolation valves on both the inlet and outlet of the device. The HA-MFV must be supplied with 70 to 100 psig filtered, clean, dry air to actuate the valves. The isolation valves are rated for 1 x 10<sup>-9</sup> scc/s He leak rate across the valve seat.

## 3.6 HA-MFV Reliability

The HA-MFV designs utilize a low mechanical and electronic components count in an effort to ensure the reliability of the device.

Mechanical and electrical -stressll tests have been used by the engineering design team including:

- STRIFE, including temperature cycling and vibration (sine and random tests)
- EMC Directive 2014/30/EU for CE Mark compliance (with a metal braided, shielded cable, properly grounded at both ends)

Hardware and software compliance testing includes:

- ODVA Compliance Certification
- Ethercat Compliance Certification

**NOTE**

All HA-MFV Models are CE Mark and RoHS compliant designs.

### 3.7 HA-MFV Cleanliness

The production process for the MKS HA-MFV Mass Flow Verifier minimizes contamination and particle generation. To ensure cleanliness, the component parts of the MKS HA-MFV Mass Flow Verifier undergo a proprietary cleaning process. The instrument is assembled and verified in a Class 100 clean room environment and then vacuum packaged in a double-bag under the same Class 100 conditions prior to shipment.

### 3.8 HA-MFV Specifications

Table 1: General Performance and Design Specification

General Performance and Design Specification	
Model and Specification	HAMFV
<b>Performance</b>	
Mass Flow Verification Accuracy	± 1.0% RDG
Mass Flow Verification Range	3 to 3000 sccm N <sub>2</sub> equivalent
Repeatability	± 0.1% RDG
Pressure Range	100 Torr
Pressure Accuracy	0.25% RDG
Temperature Display	0° to 100° C

General Performance and Design Specification	
Model and Specification	HAMFV
Temperature Readout Units	°C
<b>Operation Ratings</b>	
Vacuum Supply Requirement	5 Torr @ 3000 sccm N <sub>2</sub>
Proof Pressure – Transducer	45 psia
Burst Pressure – Transducer	150 psig
Temperature Coefficients Zero Span	<0.005% FS/°C <.04% RDG/°C
Pneumatic Air Supply Temperature Minimum Maximum	70 psig 100 psig
Warm-Up Time	4 hrs
Normal Operating Temperature Range	10°C to 40°C
Storage Humidity	0 to 95% Relative Humidity, non-condensing
Storage Temperature	-20° to 6°0C (-4° to 140°F)
ROHS Compliant	Yes
Electromagnetic Compatibility	CE Compliant – MKS Document Document Number: MKS-CR-1197

Table 2: Electrical Specification

Electrical Specification			
I/O Type	Electrical Connection	MFC Connector Design	Power Supply and Consumption
DeviceNet	5-pin Male Trunkline Connector	Power and Digital Communications	+11 – 24V, < 4 Watts
Ethercat	5-pin M8 Connector	Power only	+24 V (±10%), < 5 Watts

Table 3: Material and Mechanical Specification

Material and Mechanical Specification	
<b>HAMFV</b>	
Valve Type	Normally Closed
<b>Leak Integrity</b>	
External (scc/sec He)	1x10-9 sccs Helium
Internal Isolation Valves (scc/sec He)	1x10-9 sccs Helium
<b>Wetted Materials</b>	
Volume Valve Seat Seals	316L Passivated/ Inconel / Incoloy 316 SST Ag Plated PCTFE with Elgiloy Diaphragm
<b>Physical Data</b>	
Surface Finish	< 32 µin Ra
Weight	23.9 lbs (10.9 kg)

**Material and Mechanical Specification**

Dimensions	7.00 in x 10.00 in x 10.00 in
------------	-------------------------------

## 4 HA-MFV Installation

This chapter describes techniques and details on how to properly handle a newly acquired HA-MFV in an effort to prepare the gas system and the HA-MFV for a safe and clean installation.

### NOTE

All documented procedures for installation and safety checks for installation of a new HAMFV by the end user supersede any procedural recommendations by MKS Instruments in this manual.

### 4.1 HA-MFV Configuration Design for In-Situ Rate of Rise Measurement

A common integration is to install the MFV in a system in a bypass line between the MFC's and the vent / vacuum source as shown in Figure 3. In this configuration, the HA-MFV serves a single gas box or a single chamber.

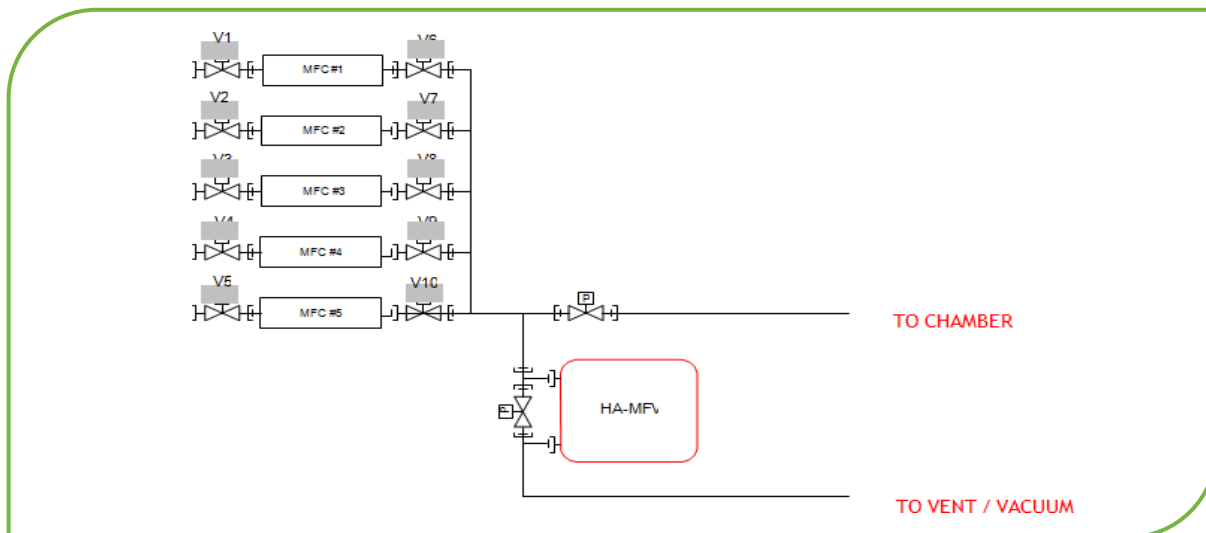

Figure 3: HA-MFV Installation Diagram 1 – Single Gas Box

A second common integration is to install the MFV in a system to serve multiple chambers as shown in Figure 4: HA-MFV Integration Diagram #2 below.

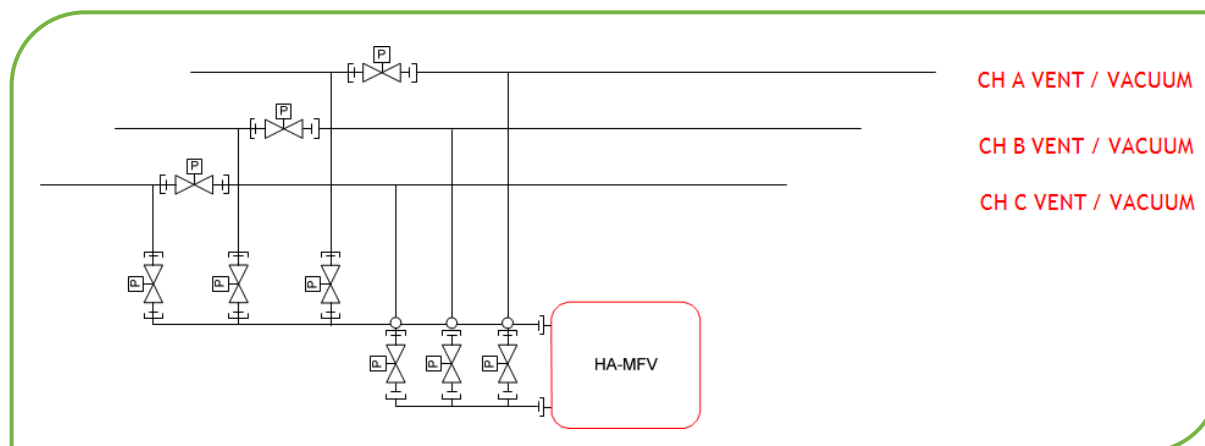

Figure 4: HA-MFV Diagram #2 – Multiple Chamber

## 4.2 Considering the HA-MFV Installation Environment

### 4.2.1 HA-MFV Installation Environment

The area around where the HA-MFV is installed should have adequate ventilation and control of the ambient humidity and temperature to meet the suggested manufacturing specification for proper operating temperatures between 10°C and 40°C.

Careful consideration should be given to the design of the installation to minimize any shock and vibration during actual operation while still allowing the user:

- Easy access to control switches and communication ports available on the top and sides of the HA-MFV
- Ability to purge and remove the device should the device require servicing

Installation of an upstream particle filter is recommended to help protect the HA-MFV fitting to avoid potential foreign material entering the HA-MFV during operation and adversely affecting the performance of the instrument.

### 4.2.2 Pre-Installation Safety Considerations

Safety is the paramount consideration while installing the instrument so it is necessary to make sure all gas lines have been purged with high purity, dry Nitrogen or other high purity dry inert gas to ensure that the lines are free of potentially harmful gases (toxic, flammable), organic contaminants, moisture, and oxygen.

**WARNING****PERSONAL SAFETY HAZARDS!**

Gas systems can contain toxic, explosive, combustible, corrosive or other gases that can present life-threatening hazards.

**ALWAYS** use appropriate personal protection equipment.

**NEVER** open a gas line unless the system has been properly purged of harmful gases. Certain gas system components may contain hazardous residuals if not properly prepared. Consult with your facility safety engineers prior to working on any gas delivery system and notify all personnel in adjacent areas to take appropriate personal safety precautions **BEFORE** working on the equipment.

**4.2.3 Unpacking the HA-MFV in a Clean Environment**

Each device is built and leak tested with helium in a cleanroom environment. The instrument is packaged using vacuum to ensure maintenance of its particle-free condition during shipment.

To maintain the integrity of the manufacturing HA-MFV packaging procedures, open and remove the HA-MFV from its protective shipping clamshell container while following clean room protocols. Inside the protective shipping clamshell container, a Calibration Certificate is available for customer records and traceability. This official document summarizes the HA-MFV accuracy of the N<sub>2</sub> manufacturing calibration utilizing NIST traceable primary standards.

Remove the HA-MFV out of the cleanroom sealed bag. Carefully inspect the HA-MFV for any sign of mechanical damage to the enclosure, gas connector fittings, electrical connectors, etc. If damage is noted on the HA-MFV, notify your carrier and MKS Service immediately.

If the HA-MFV needs to be returned to MKS for repair, two forms must be completed:

- RMA Request Form to properly document the reason for return. This form is available on the MKS web site at: <http://www.mksinst.com/service/serviceeraform.aspx>
- Health and Safety Form to ensure the safety of handling the HA-MFV once it is in a MKS Service Center. This form is available on the MKS web site at: <http://www.mksinst.com/service/HealthAndSafetyForms.aspx>

Once MKS Service receives the completed forms, we will provide an RMA number and contact details for shipping the device back to MKS.

**4.2.4 Mounting Hardware for Installing the HAMFV**

The HA-MFV is designed with tabs on the base of the instrument that can be used to secure the HA-MFV in a gas panel location. Dimension drawings which detail the physical attributes of the HA-MFV are provided in Figures 5 and 6.



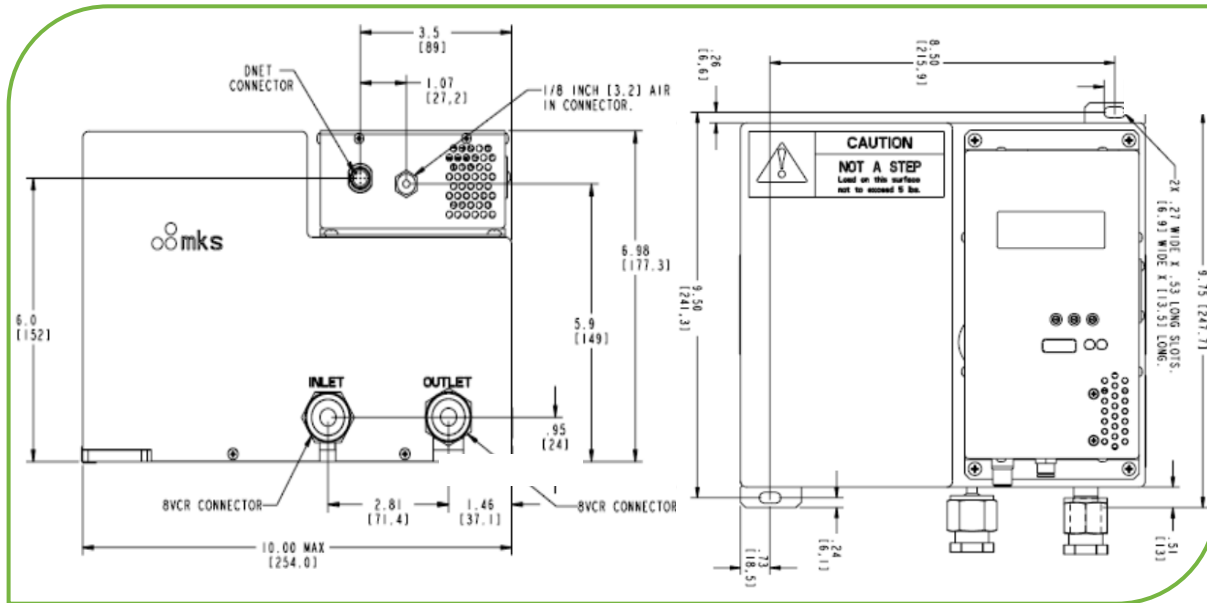

Figure 5: Front and Top View of HA-MFV

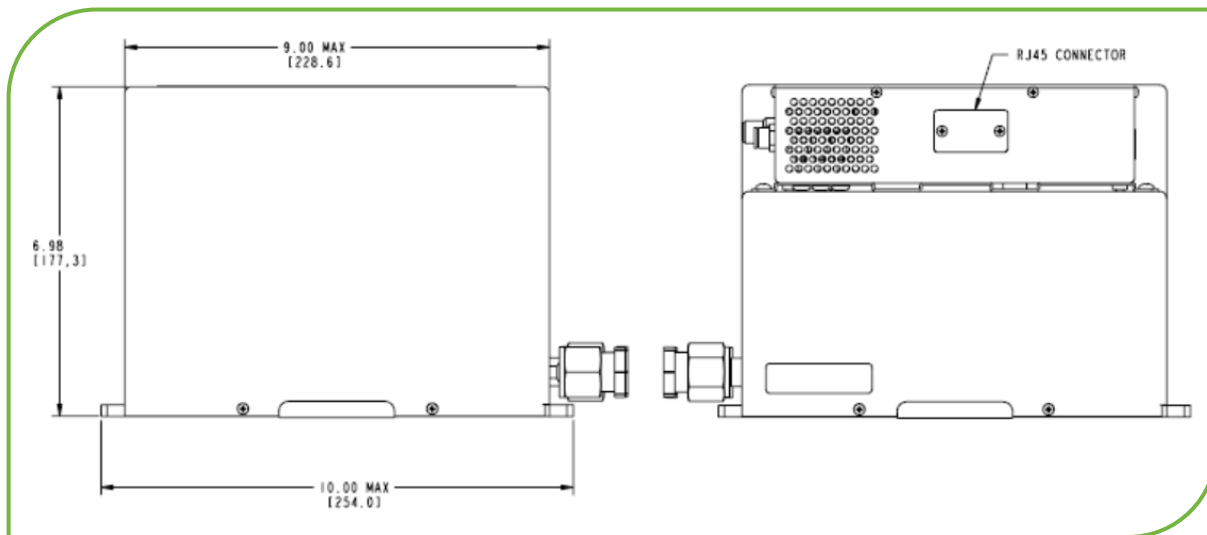

Figure 6: Side View of HA-MFV

#### 4.2.5 Establishing a Leak Tight Seal for the HA-MFV

With the HA-MFV body mounted in its gas panel location, prepare the HA-MFV Mass Flow Verifier gas supply and vacuum supply process connections:

- Flow clean, dry, inert purge gas across the fittings to minimize particle contamination during installation. Use only purge gases that are approved for your process and compatible with the wetted materials of the HA-MFV Mass Flow Verifier.
- Use the appropriate face seal gasket material that is chemically compatible with the process gases in use.
- Secure the gas supply and vacuum supply fitting connections according to the fitting manufacturer's instructions. DO NOT over tighten connections.

---

**CAUTION**

Do not over-tighten the HA-MFV Mass Flow Verifier VCR connections as this can result in damage to the VCR bead surface resulting in leaks.

---

**CAUTION**

Do not grasp the HA-MFV Mass Flow Verifier electronics enclosure to provide torque resistance while tightening the VCR connections as this can result in damage to the device. Use a backing wrench when tightening these connections.

---

#### 4.2.6 Connect Pneumatic Airline to HA-MFV Fitting

Connect the pneumatic air supply to the fitting on the front panel. Verify that the air supply pressure is set to at least 70 psig at the inlet to the HA-MFV Mass Flow Verifier. Do not exceed a pressure of 100 psig.

#### 4.2.7 Applying Power and Signal Cables to the HA-MFV

Connect the appropriately designed power and signal cables to the HA-MFV interface. Secure the cable to posts on each side of the GPC connector.

---

**CAUTION**

Before connecting any cable to the HA-MFV, verify that the power supply being used for this application meets the MKS's recommendation for voltage and current ratings. DO NOT submit the HA-MFV to an over voltage condition in order to avoid damaging the device during power up.

---

**NOTE**

Before connecting any cable to the HA-MFV, verify that all pinouts for power and signals match those for the I/O type being used.

---

### 4.3 Digital I/O Connections

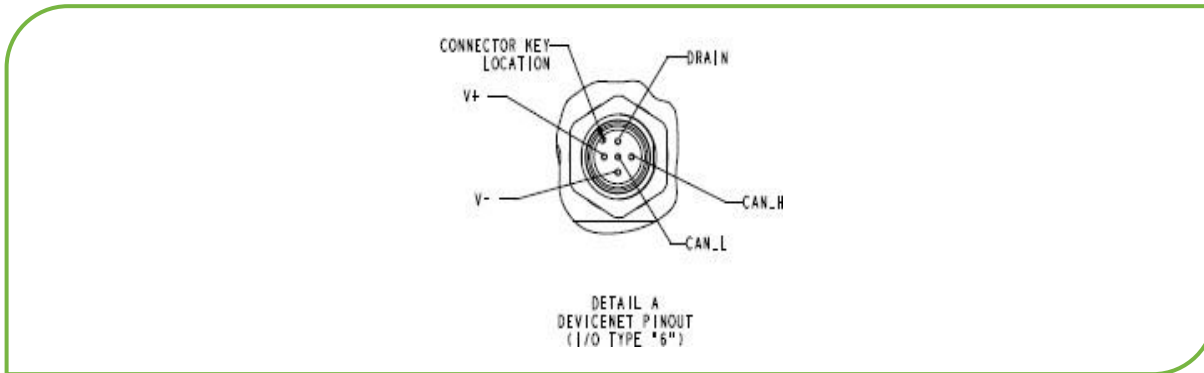

Figure 7: DeviceNet I/O Connection Located on Electronics Enclosure

#### 4.3.1 DeviceNet Communications Protocol

- DeviceNet communication is a master/slave (HA-MFV) relationship comprised of a physical layer that makes up the trunk-line topology connecting devices and the data-link layer that is automatically capable of arbitrating message traffic between the master and the GFC slave.
- The HA-MFV Mass Flow Verifier complies with the ODVA DeviceNet Specification Volume I and Volume II [1, 2], and the SEMI Standards Common and Specific Device Models [3, 4]. Refer to those documents for a complete functional description of the G series Pressure Controller Device along with the MKS G-Series Pressure Controller DeviceNet Supplement (1027599-001 REV D)

#### HA-MFV DeviceNet Features

**LED Status Indicators** — Two bi-color LED status indicators are located on the top of the HA-MFV Electronics enclosure for network (NET) and module (MOD) status. During initialization, the NET and MOD will toggle green and red for 2 seconds, and the MOD light will remain solid green. Once a DeviceNet network has been detected by the GPC, the NET LED will begin blinking green. Once connected to the DeviceNet network, the NET LED will be solid green.

**Baud Rate Selection** — Default factory baud rate is 500 kps. Baud rate selection can be physically selected by using the 4-position rotary switch on the top of the PPC enclosure to select one of the three allowable choices (125, 250, 500 kps) or by placing the switch to PGM and using DeviceNet programming commands (the value is read from the non-volatile memory).

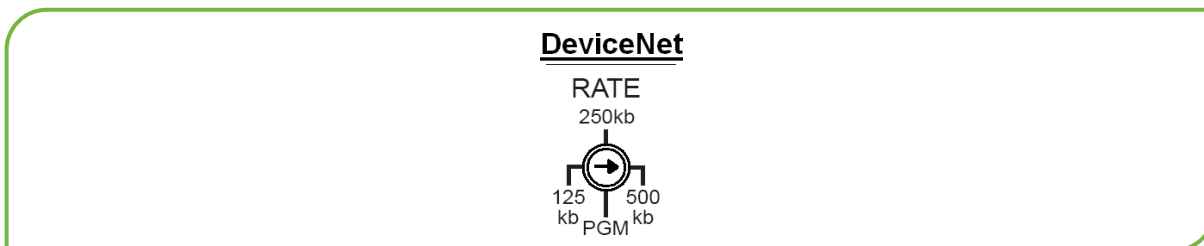

Figure 8: DeviceNet 4-Position Rotary Switch for Baud Rate Selection

**DeviceNet MAC ID (Node Address) Switches** — A pair of rotary switches located on the top of the HA-MFV Electronics enclosure are used to set a unique node address for every device on the network. The factory default is 55. Valid switch positions for a DeviceNet network are from 00 to 63. The MSD (most significant digit) switch represents an increment of 10 (0, 10, 20, etc...60), while the LSD (least significant digit) switch represents an increment of 1 (0-9).

It is also possible to use the PGM position on the MSD switch and set the node address using DeviceNet commands. The master will read the node address from non-volatile memory.

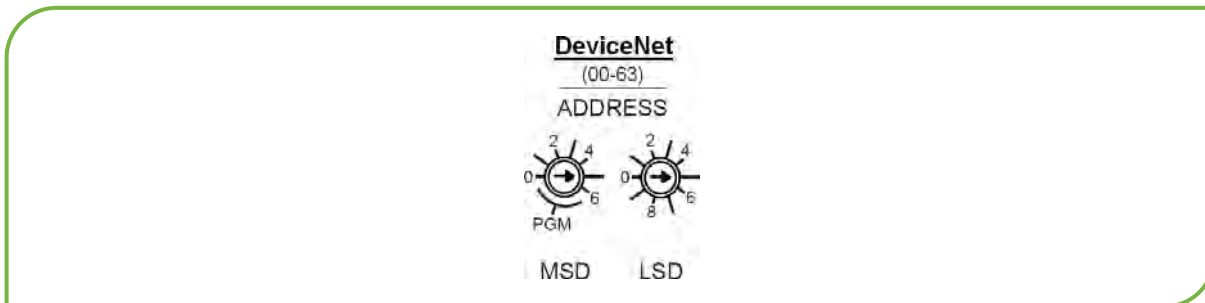

Figure 9: DeviceNet Pair of Rotary Switches

## 4.4 A-MFV EtherCat Communication

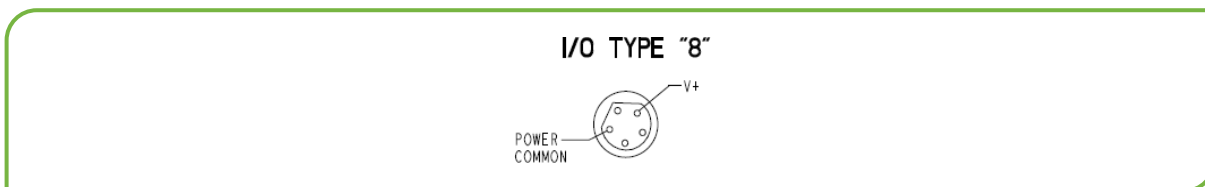

Figure 10: HA-MFV EtherCat I/O

### 4.4.1 EtherCat Communication Protocol

- Ethercat is a high performance Ethernet based fieldbus network protocol that takes advantage of the efficient way messages between the master and slave devices propagate through the network. Messages or instructions from the master are passed through all each slave device (node), and corresponding data from the slave device is added to the output message that is going to the next node in the network. This process continues throughout the network and, when the message arrives back at the master, every slave has received new input data from the master and returned new output data to the master.
- Ethercat requires an ESI file that provides the master with an appropriate configuration file specific to a HA-MFV Model.
- Additional information on I/O Protocol is available in the MKS HA-MFV Ethercat Communication Supplement

### ***HA-MFV Ethercat Features***

Two Ethernet ports marked <IN> and <OUT> are used to propagate messages from the master (IN), adding any data to the string and then allowing message to pass to the next slave or node (OUT).

There are three LEDs for Power (PWR), Network communication (RUN), and network issues (ERR).

LED status indicators function as follows:

- When power has been established, the PWR LED will turn solid green.
- The RUN LED will remain dark until a network connection between the master and slave has been established and the device has been put in an operational mode by the master. At this time, the slave device will respond to messages from the master and the LED is solid green.
- The ERR LED stays dark as long as there are no issues between the master and the slave. If an issue is detected, the LED will flash red.

ECAT ID consists of three rotary switches that provide an option of manually setting the node address (function is normally automatic from the master). A maximum of 4095 distinct addresses can be set by these rotary switches and it is important to note that these switches are in HEX (max setting FFF = 4095 decimal).

- Ethernet port on the side of the electronics enclosure that provides access to the embedded Web Browser (see Appendix B).

## **4.5 Perform He Leak Check to Verify HA-MFV Seals**

Perform appropriate helium leak checking of the HA-MFV Mass Flow Verifier gas supply and vacuum supply line connections to verify the integrity of the face seals. The internal isolation valves can be opened / closed through the DeviceNet interface to isolate and identify any leaks in the system. Alternatively, the diagnostic interface may also be used to perform this task.

## 5 HA-MFV Operation

### 5.1 Pre-Operation Procedures

#### 5.1.1 Warm Up Device Prior to Use

After installation, allow the MKS HA-MFV Mass Flow Verifier to warm up under power for a minimum of 4 hours prior to taking mass flow verification measurements.

If capacitance manometer zero has shifted during shipping and installation, the HA-MFV Mass Flow Verifier may be re-zeroed by following the specific procedures outlined in Chapter 6: Maintenance and Troubleshooting.

---

#### **NOTE**

**Additional details on how to execute various services for digital I/O are provided in Appendix B and C of this manual.**

---

#### 5.1.2 Perform Device Leak Check on HA-MFV

Prior to performing mass flow verification measurements, it is important to verify that the HA-MFV Mass Flow Verifier has not sustained damage during shipment or installation that would compromise its internal to external leak integrity or its leak integrity across the inlet and outlet isolation valves. An automated **-Device Leak Check** service has been provided to perform this verification.

During the Device Leak Check service, the HA-MFV will be isolated from the attached process gas and vacuum systems by its inlet and outlet isolation valves. Its rate of pressure rise will be monitored over a pre-determined length of time. Existence of a device leak rate, expressed in Torr / second, above the threshold value is cause for further troubleshooting and analysis prior to performing mass flow verifications.

The following is an example of the steps to properly perform to leak check on a HA-MFV over DeviceNet Primary I/O:

- Establish both an explicit I/O and a polled I/O connection to the HA-MFV.
- Start the vacuum system if it has not already been started.
- Start the HA-MFV with the S-Device Supervisor / Start Service.
- Open the inlet and outlet isolation valves within the HA-MFV with appropriate commands to the S-Flow Verifier object. (see How to Actuate the Isolation Valves).
- Using clean inert gas initiate gas flow through the HAMFV
- Close the upstream HAMFV valves and stop gas flow to the HAMFV.
- Continue to pump on the HAMFV. Allow the vacuum system to pump the internal device pressure below 5 Torr. Set the length of time over which to measure the pressure rise in the S-Flow Verifier / Service Time Constant attribute.

- Set the device leak check max pressure in the S-Flow Verifier / High Pressure Service Constant attribute. If the internal device pressure rises above the leak check max pressure, the device leak check service will immediately terminate.
- Execute the S-Flow Verifier / Device Leak Check Service.
- Continuously monitor the service status byte through the polled I/O connection.
- When the service status becomes inactive, request the measured device leak rate with an explicit query to the S-Flow Verifier / Device Leak Rate attribute.

Compare the measured device leak rate with the recommended leak rate threshold and take appropriate action. For accurate low flow rate measurements, MKS Instruments specifies a device leak rate not to exceed 0.01 mTorr / s. To end the Device Leak Check Service prior to completion, execute the S-Flow Verifier / Reset Service. Verify stable ambient environment temperature during the device leak test. Purge the device with clean, dry, inert gas as needed to remove moisture.

### 5.1.3 Perform a System Leak Check

Prior to performing mass flow verification measurements, it is important to verify that the system to which the mass flow verifier is attached is leak tight. System leaks can present a safety hazard to operators (in the event toxic, corrosive, or flammable process gases are used) and / or result in inaccurate validations of mass flow controllers as the HA-MFV reports flow into the inlet process gas connection (whether that flow is gas delivered by the MFC under test, or gas leaks into or out of the system from the environment, or a combination of both). An automated **-System Leak Check** service has been provided to perform this verification.

During the System Leak Check service, the HA-MFV will be connected to the attached process gas system. The rate of pressure rise of the entire system will be monitored over a pre-determined length of time.

Existence of a system leak rate, expressed in Torr / second, above the threshold value is cause for further troubleshooting and analysis prior to performing mass flow verifications.

For multiple MFC systems, the system leak check can be performed on each individual MFC to determine which MFC process connection is leaking. The steps below describe a system leak check on an individual MFC.

The following example shows the steps to complete a **System Leak Check** on an individual MFC, over DeviceNet primary I/O:

- Open both the inlet and outlet isolation valves within the HA-MFV with appropriate commands to the S-Flow Verifier object. (see How to Actuate the Isolation Valves).
- Close the isolation valve upstream of the MFC under test, open the isolation valve downstream of the MFC under test, and provide a full scale setpoint to the MFC.
- Allow the vacuum system to pump the system pressure below 5 Torr.
- Set the length of time over which to measure the pressure rise in the S-Flow Verifier / Service Time Constant attribute.

- Set the system leak check max pressure in the S-Flow Verifier / High Pressure Service Constant attribute. If the system pressure rises above the leak check max pressure, the system leak check service will immediately terminate.
- Execute the S-Flow Verifier / System Leak Check Service when the pressure reported from the HA-MFV falls below the system leak check max pressure.
- Continuously monitor the service status byte through the polled I/O connection.
- When the service status becomes inactive, request the measured system leak rate with an explicit query to the S-Flow Verifier / System Leak Rate attribute.
- Provide a zero setpoint to the MFC, close the isolation valve downstream of the MFC under test, and open the isolation valve upstream of the MFC under test.

To end the System Leak Service prior to completion, execute the S-Flow Verifier / Reset Service. Compare the measured system leak rate with the recommended leak rate threshold and take appropriate action. For accurate low flow rate measurements, MKS Instruments specifies a device leak rate not to exceed 0.01 mTorr/ s. Verify stable ambient environment temperature during the device leak test. Purge the device with clean, dry, inert gas as needed to remove moisture. Prior to performing a system leak check on another MFC, it is necessary to perform a Manifold Purge Service to clear the inlet manifold of the prior process gas.

#### 5.1.4 Perform a Manifold Purge

Between mass flow verifications with different process gases, or between system leak checks on different MFC's, it is necessary to execute a manifold purge service to clear inlet manifold of the prior process gas. Failure to execute a manifold purge service could lead to reactions between incompatible gases within the inlet line resulting in damage to the instrument or to inaccurate verification of the mass flow rate of the MFC as the mixture of gases in the manifold may have different physical properties than the MFC process gas.

The following example shows the steps to execute a Manifold Purge over DeviceNet Primary I/O:

- Open both the inlet and outlet isolation valves within the HA-MFV with appropriate commands to the S-Flow Verifier object.
- Continuously monitor the system pressure through the polled I/O connection.
- Allow the vacuum system to pump the system pressure below 0.1 Torr.
- When the pressure has fallen below 0.1 Torr, open the isolation valve downstream of the MFC under test and provide a setpoint to the MFC to provide gas flow.
- Set the number of purge cycles to complete in the S-Flow Verifier / Purge Cycles attribute.
- Set the length of time for a single purge cycle in the S-Flow Verifier / Service Time Constant attribute.
- Execute the S-Flow Verifier / Manifold Purge Service
- Continuously monitor the service status byte through the polled I/O connection to determine when the service has completed.

To end the Manifold Purge Service prior to completion, execute the S-Flow Verifier / Reset Service.



### 5.1.5 Check Gas Type and Range Prior to Verification

Prior to using the HA-MFV for mass flow verification, check that the gas type and flow rate range are within the mass flow verification performance envelope of the instrument.

Currently, the HA-MFV supports in excess of 60+ commonly used semiconductor gases, listed in the table below, over widely varying flow rate ranges. Additional gases (beyond those listed in the table below) may be available with your instrument. MKS Instruments, Inc. continues to add new gases to the list of verifiable gases as new thermal property data and laboratory test data becomes available. In addition, it is possible to upgrade the capabilities of the device in the field by downloading new gas property tables across the DeviceNet interface.

To check the list of supported gases available with the HA-MFV, request the list of supported gases through the S-Flow Verifier / Supported Gases attribute. An explicit request will return an array of SEMI numbers for the supported gases.

The data contained in the table below reflects the most current information available as of the month and year of publication. Due to continuing research and development activities, these product specifications are subject to change without notice.

For low vapor pressure gases, the user is responsible for determining the maximum verifiable flow rate of gas that avoids condensation of the gas at any point in the inlet process gas stream based on system configuration and operating temperature. Inlet and outlet pneumatic valves were not designed for liquid service. Device can be damaged by attempting to validate two-phase flows.

It is the user's responsibility to check chemical compatibility of the gas with the materials of construction disclosed in the technical specifications of this manual. Optimum sequencing of gas verifications and determination of proper purge duration to minimize the buildup of reaction products internal to the device is the responsibility of the user.

Table 4: HA-MFV Mass Flow Verification Range as a Function of Gas Type

HA-MFV Gas Table				
SEMI Gas Number	Name	Formula	High Flow Rate	Low Flow Rate
1	Helium	He	3000	4.2
2	Neon	Ne	3000	4.2
4	Argon	Ar	3000	4.2
5	Krypton	Kr	3000	4.2

HA-MFV Gas Table

SEMI Gas Number	Name	Formula	High Flow Rate	Low Flow Rate
6	Xenon	Xe	3000	4.2
7	Hydrogen	H <sub>2</sub>	3000	3.0
8	Air		3000	3.0
9	Carbon Monoxide	CO	3000	3.0
10	Hydrogen Bromide	HBr	3000	3.0
11	Hydrogen Chloride	HCl	3000	3.0
12	Hydrogen Fluoride	HF	3000	3.0
13	Nitrogen	N <sub>2</sub>	3000	3.0
14	Deuterium	D <sub>2</sub>	3000	3.0
15	Oxygen	O <sub>2</sub>	3000	3.0
18	Fluorine	F <sub>2</sub>	2722	3.0
19	Chlorine	Cl <sub>2</sub>	2545	3.0
20	Water	H <sub>2</sub> O	2515	3.0
25	Carbon Dioxide	CO <sub>2</sub>	2227	3.0
26	Nitrogen Dioxide	NO <sub>2</sub>	2229	3.0
27	Nitrous Oxide	N <sub>2</sub> O	2151	3.0

HA-MFV Gas Table

SEMI Gas Number	Name	Formula	High Flow Rate	Low Flow Rate
28	Methane	CH <sub>4</sub>	2281	3.0
29	Ammonia	NH <sub>3</sub>	2369	3.0
30	Ozone	O <sub>3</sub>	2097	3.0
31	Phosphine	PH <sub>3</sub>	2218	3.0
33	Methyl Fluoride	CH <sub>3</sub> F	2131	3.0
35	Arsine	AsH <sub>3</sub>	2111	3.0
38	Ethylene	C <sub>2</sub> H <sub>4</sub>	1829	3.0
39	Silane	SiH <sub>4</sub>	1859	3.0
42	Acetylene	C <sub>2</sub> H <sub>2</sub>	1853	3.0
43	Germane	GeH <sub>4</sub>	1689	3.0
48	Boron Trifluoride	BF <sub>3</sub>	1622	3.0
49	Trifluoromethane	CHF <sub>3</sub>	1560	3.0
53	Nitrogen Trifluoride	NF <sub>3</sub>	1506	3.0
58	Diborane	B <sub>2</sub> H <sub>6</sub>	1225	3.0
61	Hexafluoropropylene	C <sub>3</sub> H <sub>6</sub>	1325	3.0
63	Carbon Tetrafluoride	CF <sub>4</sub>	1308	3.0

HA-MFV Gas Table

SEMI Gas Number	Name	Formula	High Flow Rate	Low Flow Rate
67	Dichlorosilane	SiH <sub>2</sub> Cl <sub>2</sub>	1325	3.0
69	Propylene	CH <sub>3</sub> CH=CH <sub>2</sub>	1219	3.0
70	Boron Trichloride	BCl <sub>3</sub>	1332	3.0
85	Dimethylamine	C <sub>2</sub> H <sub>7</sub> N	1098	3.0
88	Silicon Tetrafluoride	SiF <sub>4</sub>	1116	3.0
89	Propane	C <sub>3</sub> H <sub>8</sub>	1049	3.0

### 5.1.6 Pump System Performance Verification

Verify pumping system performance by measuring absolute pressure immediately downstream of the mass flow verifier from 3-3000 sccm N<sub>2</sub> flow using a 100 Torr capacitance manometer.

The vacuum supply should be capable of maintaining a base pressure of 10 Torr at the exit of the HA-MFV against an incoming flow rate of 3000 sccm N<sub>2</sub>.

## 5.2 HA-MFV Operation Procedures

### NOTE

Additional details on how to execute a flow verification service for digital I/O are provided in Appendix B and C of this manual.

### 5.2.1 Flow Verification Service and Monitor for Completion

Once gas type and range have been verified as measureable, it is possible to begin mass flow verifications with the HA-MFV Mass Flow Verifier.

The following example shows the steps to execute a Flow Verify Service with DeviceNet I/O:

- Open both the inlet and outlet isolation valves within the HA-MFV with appropriate commands to the S-Flow Verifier object. (see How to Actuate the Isolation Valves).

- Provide a setpoint to the MFC to provide gas flow if desired setpoint has not already been established.
- Execute the S-Flow Verifier / Flow Verify service request. As part of the service request, the following data will be sent to the HA-MFV.
  1. MFC Position
  2. SEMI Gas Number
  3. Gas Flow Rate Set Point
- Continuously monitor the service status byte through the polled I/O connection to determine when the service has completed.

To end the Flow Verify Service prior to completion, execute the S-Flow Verifier / Reset Service.

### 5.2.2 Read Measured Mass Flow Rate

On successful completion of the S-Flow Verify Service, query the HA-MFV to read the measured mass flow.

The following example shows how to read the measured flow rate over DeviceNet primary I/O:

- Get the measured mass flow rate from the S-Flow Verifier / Flow attribute.

---

#### **NOTE**

**If a fault condition occurs during the mass flow verification process, the measured mass flow rate will be reported as zero. Further details of the fault condition can be determined per the primary I/O specification documents.**

---

## 6 Maintenance and Troubleshooting

### 6.1 General Information

In general, only minor periodic maintenance is required to keep the HA-MFV Mass Flow Verifier operating at maximum accuracy. Proper installation and operation of the HA-MFV to the guidelines presented previously will protect the instrument subsystems and ensure reliable operation over the life of the device. Periodic maintenance activities should include visual checks for wear on the interface cable, inspection of the enclosure for visible signs of damage, and examination of the pneumatic air supply tubing for leaks or restrictions.

Periodic recalibration of the instrument at an authorized MKS Calibration and Service Center is required with a 1 year recalibration interval recommended. Refer to the inside back cover of this instruction manual for a complete list of MKS Calibration and Service centers.

If an MKS HA-MFV Mass Flow Verifier fails to operate properly upon receipt, check for shipping damage, and check the interface cable for correct continuity, grounding, pin outs, and voltage levels. Any damage should be reported to the carrier and MKS Instruments immediately. If there is no obvious damage and the troubleshooting instructions outlined on page 36 fail to resolve the problem, obtain an RMA Number (Return Material Authorization Number) as outlined on page 35 and complete a Health and Safety Form shown on page 89 before returning the unit to MKS Instruments for service.

### 6.2 Zeroing the MKS HA-MFV Mass Flow Verifier Pressure

For best accuracy, the pressure zero setting may require adjustment on initial installation.

---

**WARNING**

**If the instrument is being used to measure dangerous gases, be sure that the system is *fully warmed up* before starting verification measurements.**

---

Once the MKS HA-MFV Mass Flow Verifier is completely warmed up for a minimum of 4 hours, it can be zeroed as required.

The *Pressure Zero Adjust* feature integrated into the MKS HA-MFV Mass Flow Verifier is a digital equivalent to the *zero adjust* potentiometer or -autozeroll pins found on many analog mass flow controllers. The feature allows the user to compensate for long term drift, universally present in analog sensor based pressure instruments exposed to harsh process environments. Approximately 0.25% of full scale zero drift per year is typical for the pressure sensor specifications.

The Pressure Zero Adjust feature may be executed via the primary I/O.

### 6.3 When to Use Pressure Zero Adjust

Use of the *pressure zero adjust* feature is appropriate when:

- The pressure sensor has been exposed to process gas pressure in excess of 25 psig.
- When ambient temperatures at installation are  $\geq \pm 10^\circ$  from the temperature at calibration (nominally 25°C).
- It is included as part of a semi-annual or annual preventive maintenance activity.
- If process pressure drift is identified that cannot be attributed to other causes (such as pump performance degradation), applying *pressure zero adjust* to the HA-MFV Mass Flow Verifier can be used as part of diagnostic efforts.

---

#### NOTE

It is not recommended to use *pressure zero adjust* each time the instrument is idle. A *pressure zero adjust* interval of 6 months should be more than adequate if the device has been left under continuous power.

---

### 6.4 How to Use Pressure Zero Adjust

To perform a pressure zero adjustment, the MKS HA-MFV Mass Flow Verifier must be pumped down to a pressure less than the pressure transducer's resolution (0.01 % of Full Scale). For the 100 Torr capacitance manometer, absolute system pressure during pressure zero adjustment should be below 5 mTorr. Zeroing a pressure transducer at a pressure above its stated minimum resolution creates a zero offset relative to the true absolute pressure. All subsequent readings are then linear and accurate relative to the offset value.

If your system can not achieve a sufficiently low pressure to set the pressure transducer zero, you may use a helium mass spectrometer leak detector with sufficient pumping capacity (to achieve the proper zeroing pressure). In this case, if possible, use an interconnect tube from the outlet of the MFV to the leak detector so that the MFV is able to rest in the same orientation as it will be during actual use.

When performing a pressure zero adjust, close both upstream positive shutoff valves and allow the system to pump down until the reported output pressure no longer changes with time. Verify that the absolute system pressure is below the pressure transducers resolution. Zero the unit by executing the Pressure Zero Adjust service available over primary I/O.

**NOTE**

- The *pressure zero adjustment* is executed by the instrument by comparing current pressure sensor reading with the zero pressure reading stored during initial calibration. The difference in these values is stored in a unique register in the instrument EEPROM. On start-up, this value loaded into memory and added or subtracted from all readings during operation.
- Because this operation offsets all readings from the pressure sensor, the user must be certain that a true absolute zero pressure condition exists before enabling the function.
- If the difference between the -at calibration and -at zero adjust pressure sensor values is greater than 2% of the pressure transducer full scale, the zero adjust will not be performed.

## 6.5 Customer Support

Standard maintenance and repair services are available through all of the regional MKS Calibration and Service Centers.

If any difficulties arise in the use of your device, or to obtain information about companion products MKS offers, contact any authorized MKS Calibration and Service Center. If it is necessary to return the instrument to MKS, then two actions must be completed before shipping: (1) a RMA (Return Material Authorization) number must be obtained and (2) a Health and Safety Form must be completed and included with the instrument.

**WARNING**

**All returns to MKS Instruments must be free of harmful, corrosive, radioactive, or toxic materials.**

### 6.5.1 Obtaining a Return Material Authorization (RMA) Number

RMA (Return Material Authorization) numbers expedite handling and ensure proper servicing of your instrument.

RMA numbers can be obtained by contacting the MKS Calibration and Service Center or through the MKS website at: <http://www.mksinst.com/service/servicehowtoorder.aspx>

**NOTE**

**Returned instruments will not be accepted without a valid RMA number displayed on the shipping container.**



### 6.5.2 Health and Safety Form

A returned instrument will not be examined without a signed Health and Safety form indicating that the unit is free of harmful materials.

The Health and Safety form can be obtained on the last page of this manual or through the MKS website at: <http://www.mksinst.com/service/servicehowtoorder.aspx>

### NOTE

Returned instruments will not be examined without a signed certificate indicating the instruments are free of harmful materials.

## 6.6 Troubleshooting Guide

Table 5: Troubleshooting Guide

Troubleshooting Guide		
Symptoms	Possible Cause	Remedy
MFV internal pressure is not displayed in 4-segment LED indicator	Device power has been turned off	Verify the device is powered with the correct input voltage
	LED indicator has been turned off	If powered, the verify the value of S-Device Supervisor / Default Display Attribute
	LED indicator has been turned to another default display mode	
	LED display has been damaged	If attribute value correct, return unit for repair service
MFV internal pressure does not change when vacuum is applied	Downstream valve has not received adequate actuation pressure	Verify pneumatic air supply is not restricted and provides minimum 80 psig at HA-MFV connection
	Device has not been started	If air supply correct, verify HA-MFV has been started by checking S-Device Supervisor / Device Status attribute
	Downstream MFV valve has not been commanded to open due to -Safe Statell setting	If device started, verify valves are set to normally open safe state by checking S-Flow Verifier / Safe State attribute

### Troubleshooting Guide

Symptoms	Possible Cause	Remedy
	Downstream MFV valve has been commanded to close due to manual actuation	If safe state correct, verify downstream valve is not overridden closed by checking S-Flow Verifier / Downstream Valve Position
	Excessive system leak over ranges internal pressure sensor	If downstream valve open, verify system is leak free by executing S-Flow Verify / System Leak Check service
	Downstream valve has been damaged	If internal pressure is not over ranged, return unit for repair and service.
MFV internal pressure does not change when mass flow controller is started	Upstream valve has not received adequate actuation pressure	Verify pneumatic air supply is not restricted and provides minimum 80 psig at HA-MFV connection
	Device has not been started	If air supply correct, verify HA-MFV has been started by checking S-Device Supervisor / Device Status attribute
	Upstream MFV valve has not been commanded to open due to -Safe Statell setting	If device started, verify valves are set to normally open safe state by checking S-Flow Verifier / Safe State attribute
	Upstream MFV valve has been commanded to close due to manual actuation	If safe state correct, verify upstream valve is not overridden closed by checking S-Flow Verifier / Downstream Valve Position
	Flow verify service has faulted	If upstream valve not overridden, verify flow verify service request has not faulted by checking S-Flow Verifier / Service Status attribute
	Excessive system leak over ranges internal pressure sensor	If service request not faulted, verify system is leak free by executing S-Flow Verify / System Leak Check service
	Upstream valve has been damaged	If internal pressure is not overranged, return unit for repair and service.

## Appendix A Web Browser Tutorial

The Web browser that is accessible via the micro usb on the top of the HA-MFV provides the user with in-situ ability to setup, change configurations, and troubleshoot device functionality. The purpose of this appendix is to provide basic instructions on:

- Establishing communications between a computer and the HA-MFV
- Monitor Mode versus Setup Mode
- <Plot> page diagnostics and saving data

### Communicating with the HA-MFV via Ethernet UDP

1. Open the **Control Panel** on the Startup menu.
2. Select Network and Sharing Center.
3. View the active networks on the laptop.

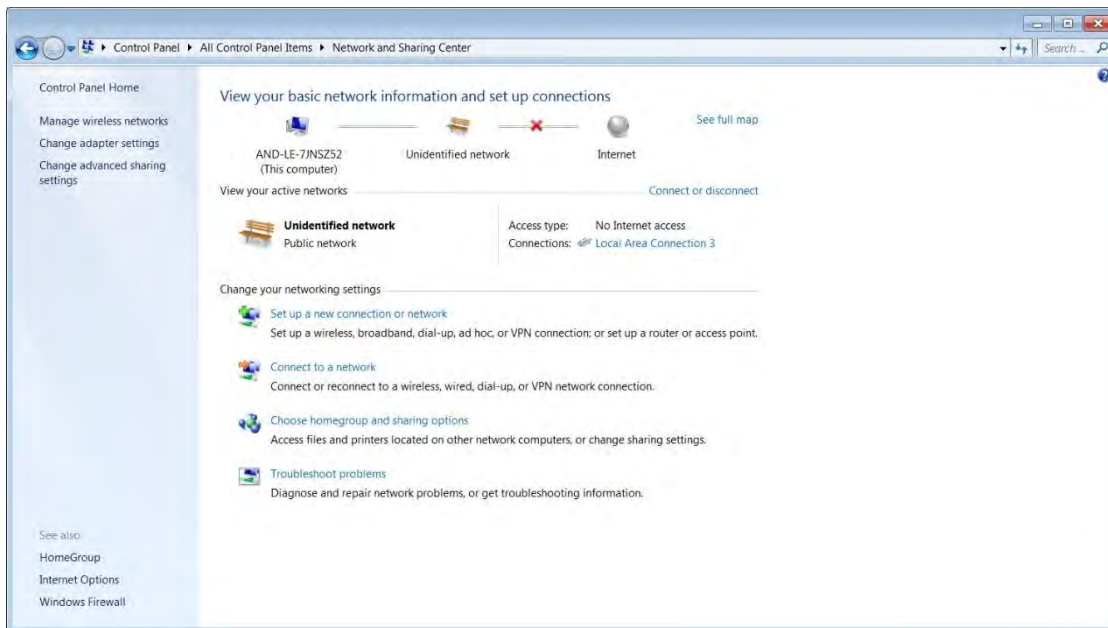

Figure 11: DeviceNet 4-Position Rotary Switch for Baud Rate Selection

4. Double-click on the local area connection to open.

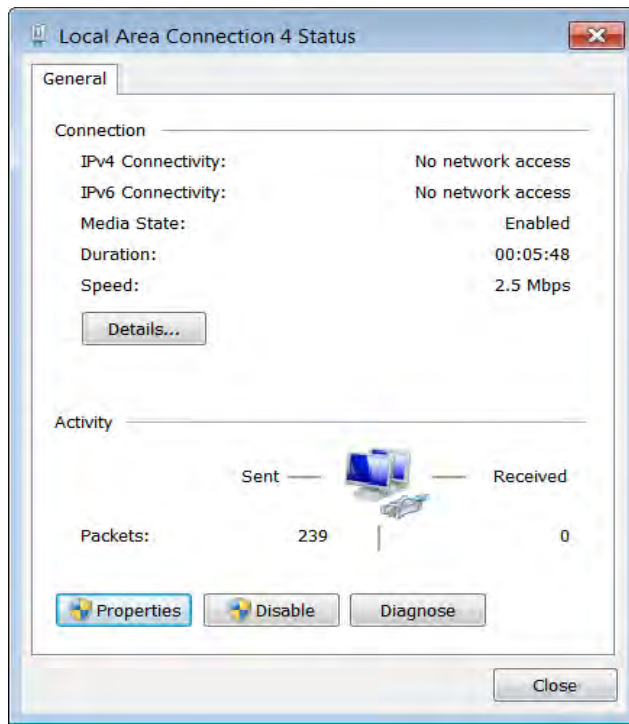

Figure 12: Local Area Connection Status

5. Select **Properties**. Scroll down and select Internet Protocol Version 4.

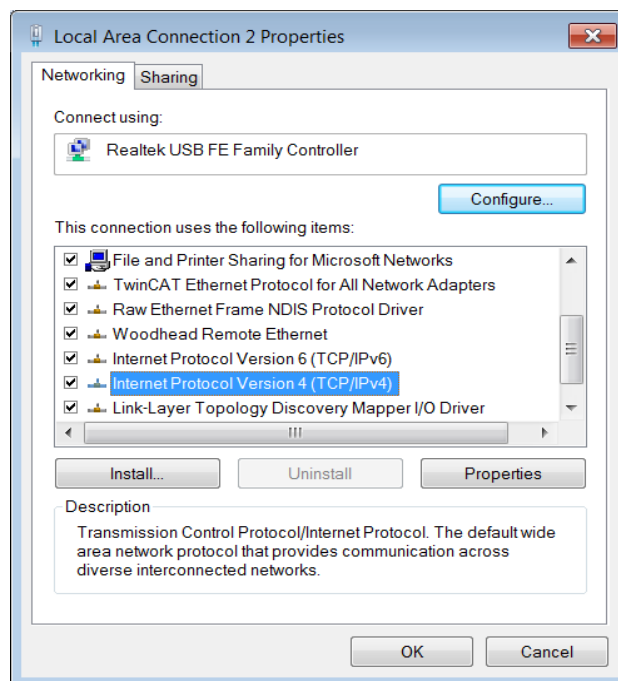

Figure 13: Internet Protocol Version 4

**6. Select Properties.**

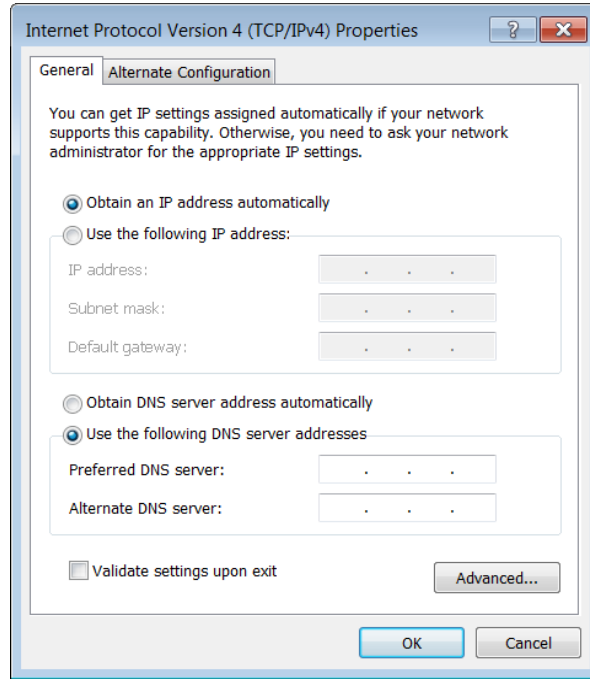

Figure 14: Properties

**7. Select Use the following IP Address.** Enter a unique IP address for the computer in the format shown below. Press the Tab key on the computer to populate the Subnet mask.

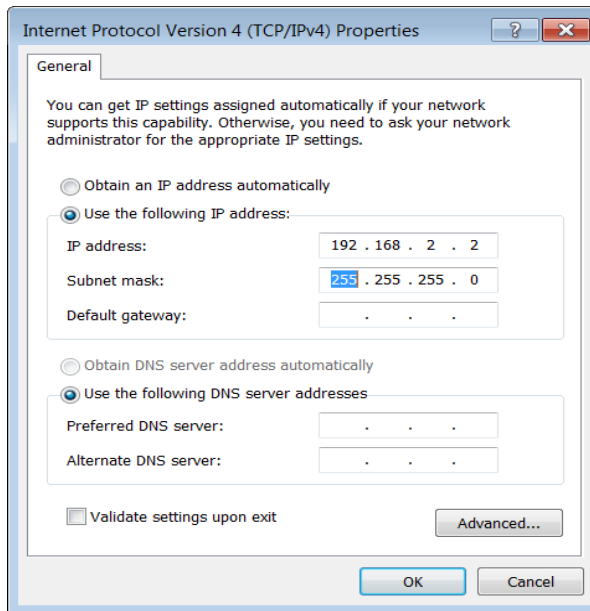

Figure 15: IP Settings

8. Click **OK** to select and close the window.
9. Once the address has been updated, close the remaining network connection windows. The laptop is ready for Ethernet communication with MKS GPC.

## Opening the Web Browser – Monitor Mode

1. Open Internet Explorer window.

---

**NOTE** Use Internet Explorer Version 11 to open the Web Browser.

---

2. Enter the IP address of the device.  
192.168.2.155 is the factory default address for the GPC.

When the Web browser opens, it shows the Device page and it is in the Monitor Mode. The Monitor Mode Device tab displays the current setup of the device:

- Gas Table Version
- Firmware Version

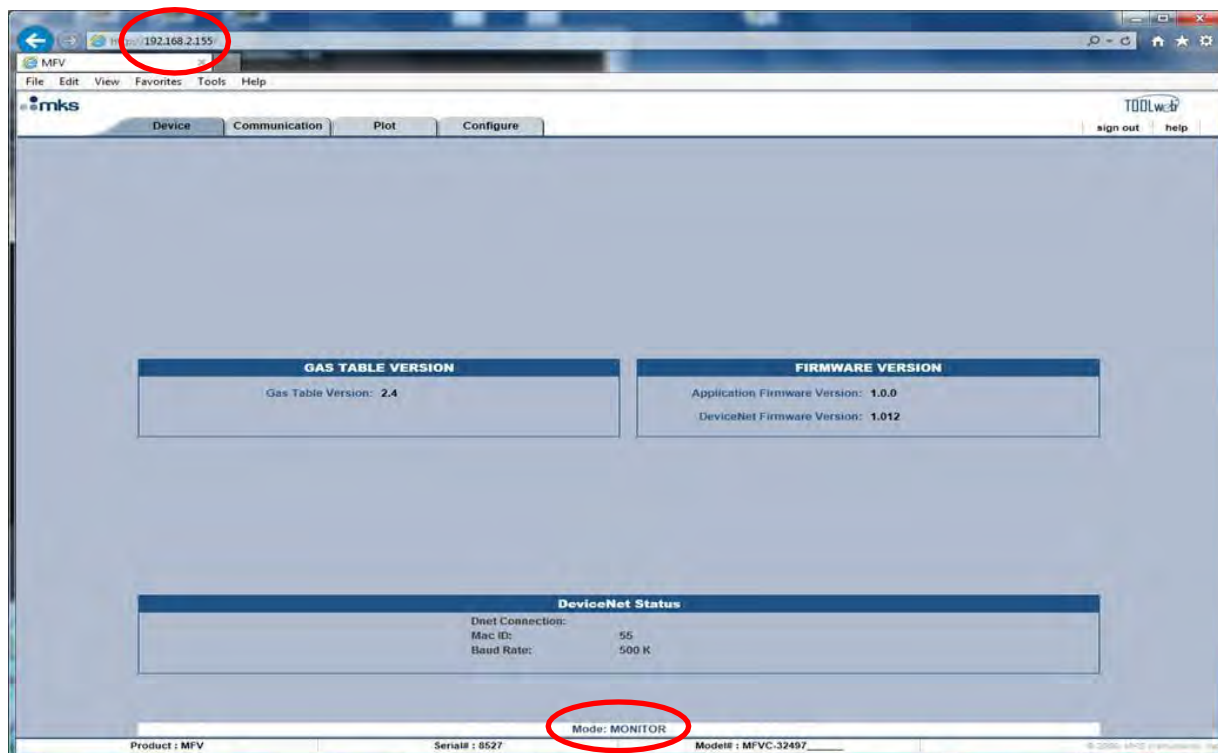

Figure 16: Web Browser Device Page in Monitor Mode

## Going to the Setup Mode

The Setup mode allows the user some ability to make changes to Device attributes by opening the tabs located at the top of the page. The Setup Mode is accessed from the Configuration tab by entering a password in the Enter Password to <Change Settings>.

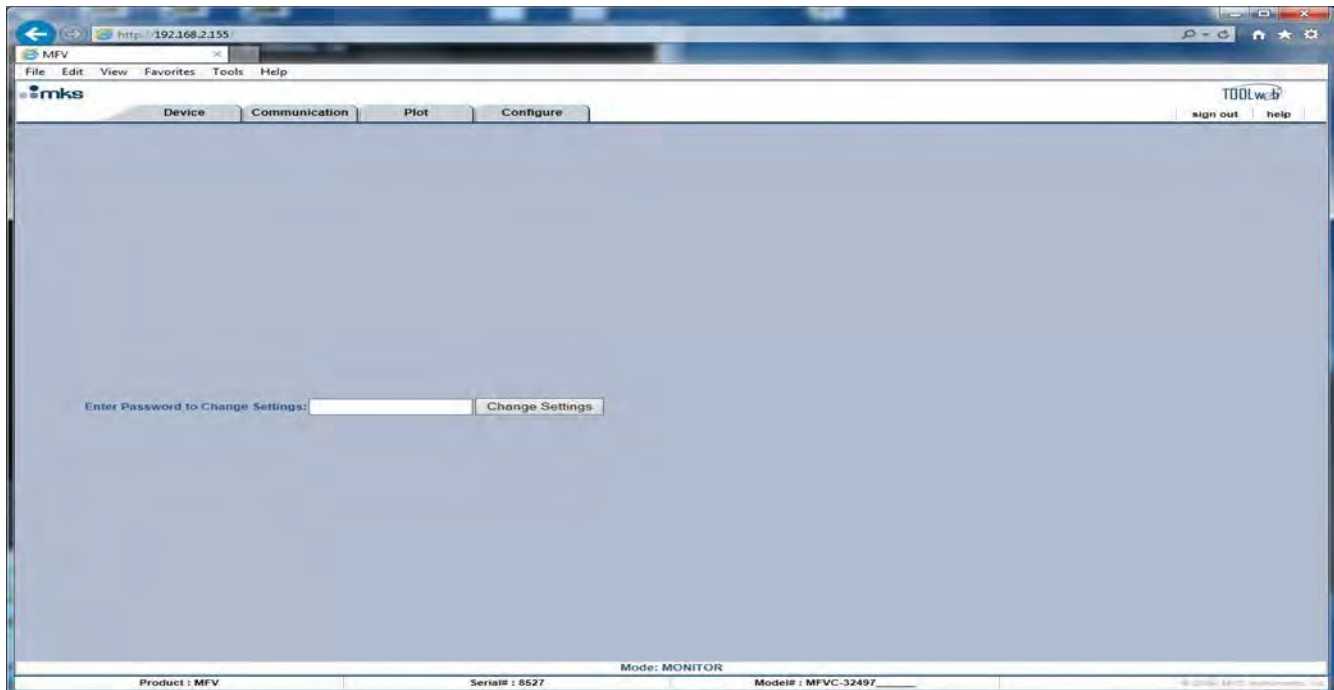

Figure 17: Enter Password to Change Settings

### NOTE

The password to change from a Monitor to the Setup mode is config.

Once the password has been entered additional page tabs and active fields within the various Web browser pages allow the user to configure the HA-MFV to a specific application.

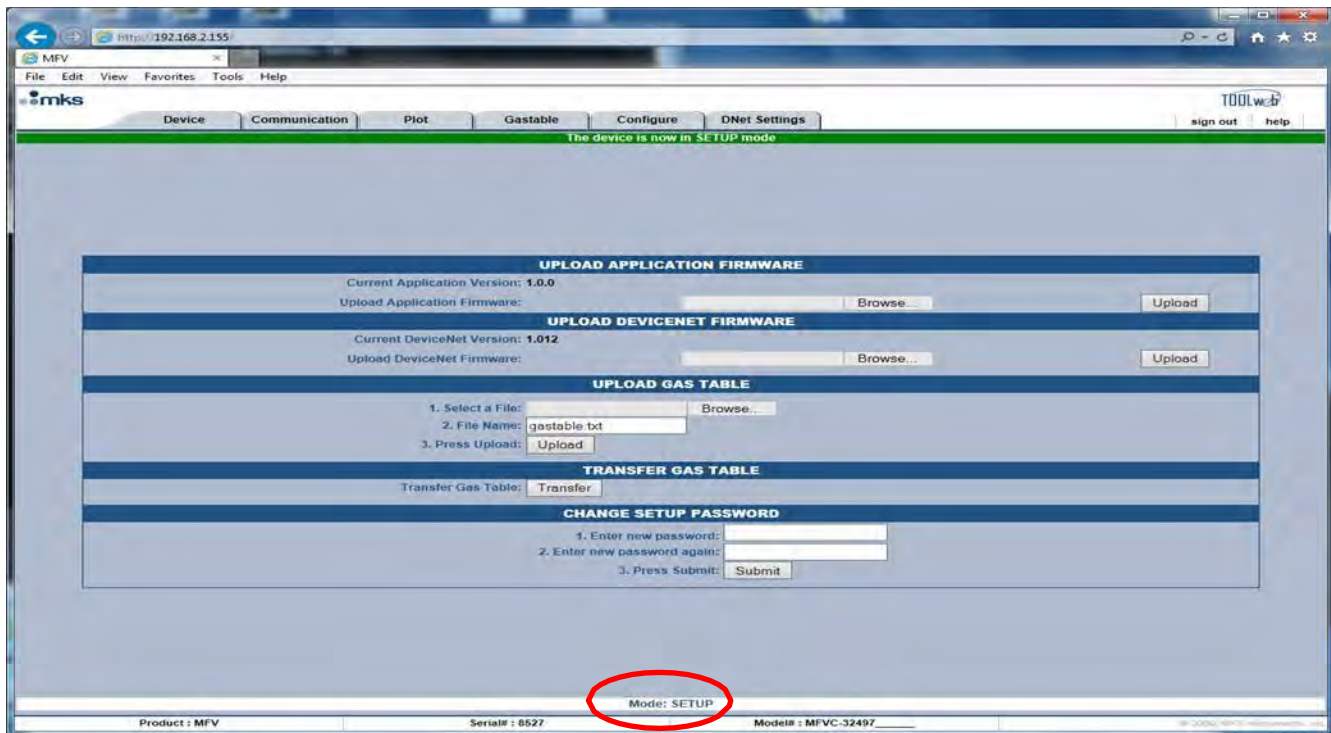

Figure 18: Additional Tabs

The table below describes basic features that can be configured via the Web browser for all G and I Series MFCs in the Setup Mode.

Table 6: Basic Features in the Setup Mode

Basic Features in the Setup Mode	
GPC Function	Browser Tab
Change the firmware version	Configuration
Update the Gas Table	Configuration
Change the setup password	Configuration
Plot and Save Data	Plot



## Utilizing the Plot Page and Saving Data

As described in the following sections, four steps must be completed to be able to actively plot selected HA-MFV parameters:

1. Create a special folder called ToolWeb in the computers local C drive.
2. Download the latest version of Java from java.com Web site.
3. Before being able to successfully save data to the ToolWeb folder, place a special Java policy document into a Java security folder located on the C drive.
4. Configure the IP Address of the HA-MFV as a -Trustedll site in order to be able to run the Java applet for the plot page.

### Special Notes:

- Use only 32 bit IE for opening the web browser
- Download 32 bit java even if the computer or laptop operating system is 64 bit

### ToolWeb Folder

1. Open the C drive on the computer.
2. Right-click and open a new folder.
3. Rename the new folder as ToolWeb. This is the folder where all data collected will be saved.

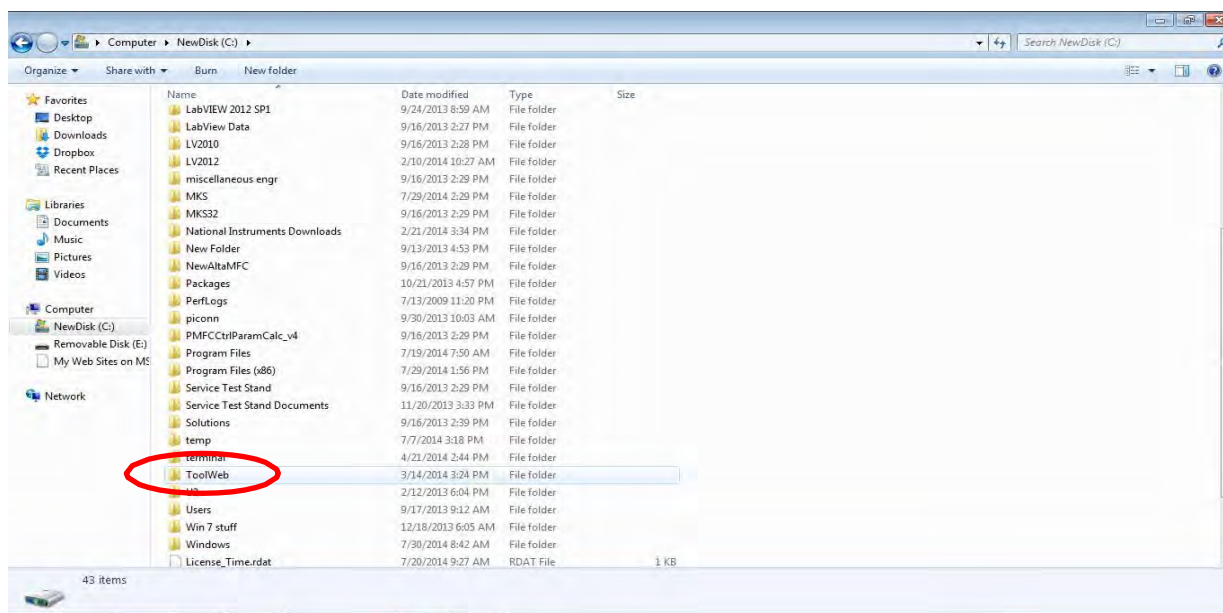

Figure 19: Creating a ToolWeb Folder for Saving Data

### Downloading Java from java.com

Go online to java.com and download the latest version available on the Java Web site.



Figure 20: Java Web Site

### Placing the java.policy in the C:drive Java Folder

A special version of the security document java.policy has been modified to allow permission to -writell to the ToolWeb folder. This document must be placed in the security folder of the Java folder located on the C drive of the computer.

1. Locate the Java folder that was just downloaded to the computer.

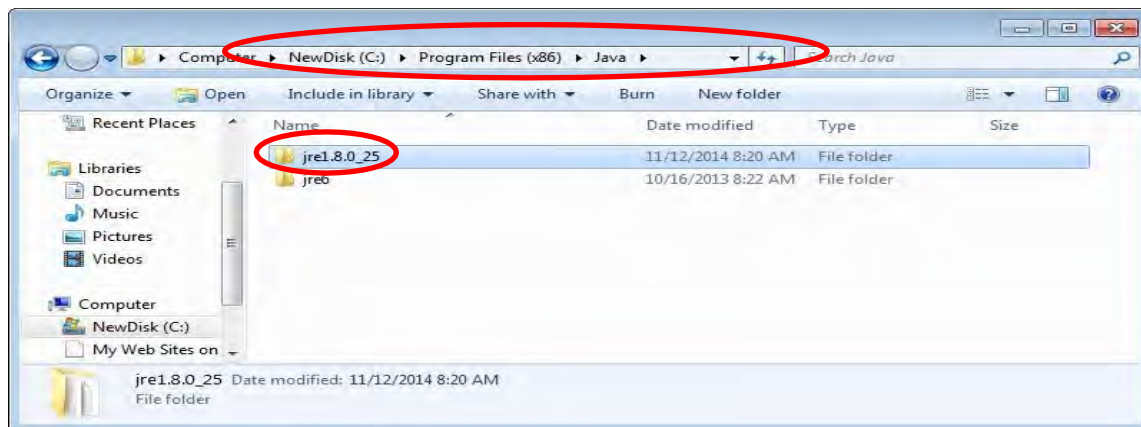

Figure 21: Java Folder from Download

- Open the folder and follow the path to the security folder.

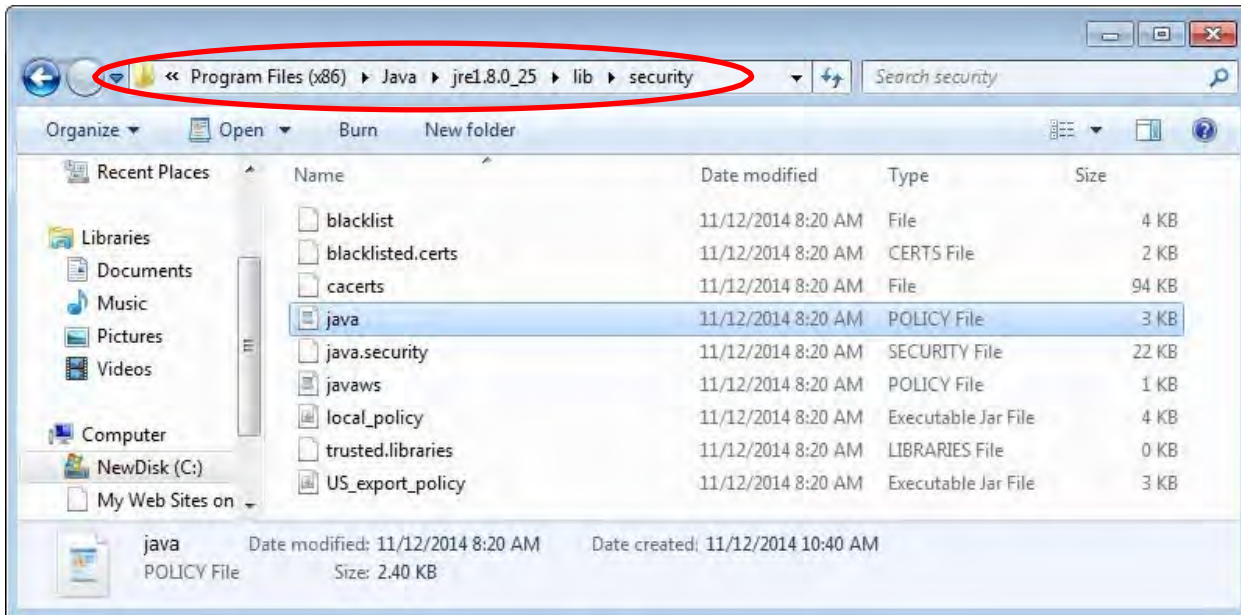

Figure 22: Java Security Folder

- Locate the new Java policy security document (supplied by MKS) and drop it into the Java security folder.

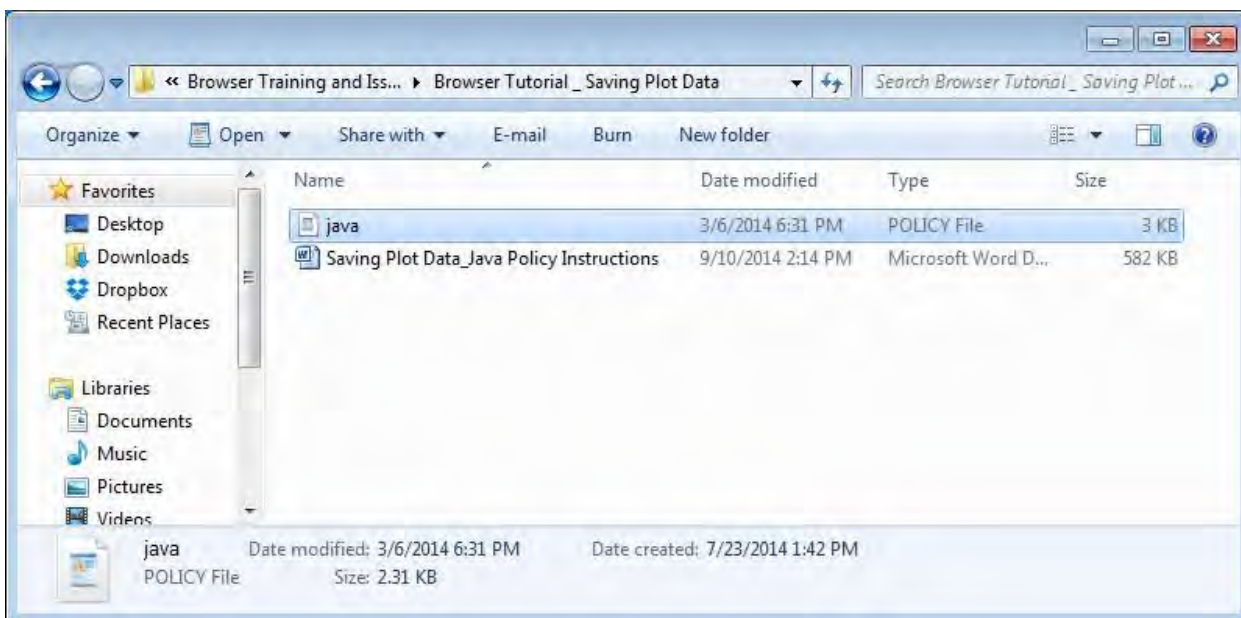

Figure 23: New Java Policy Security Document

**NOTE**

If you do not want to overwrite the original java.policy file, change the name of the original file to java\_old (as shown in the example below) to keep both files.

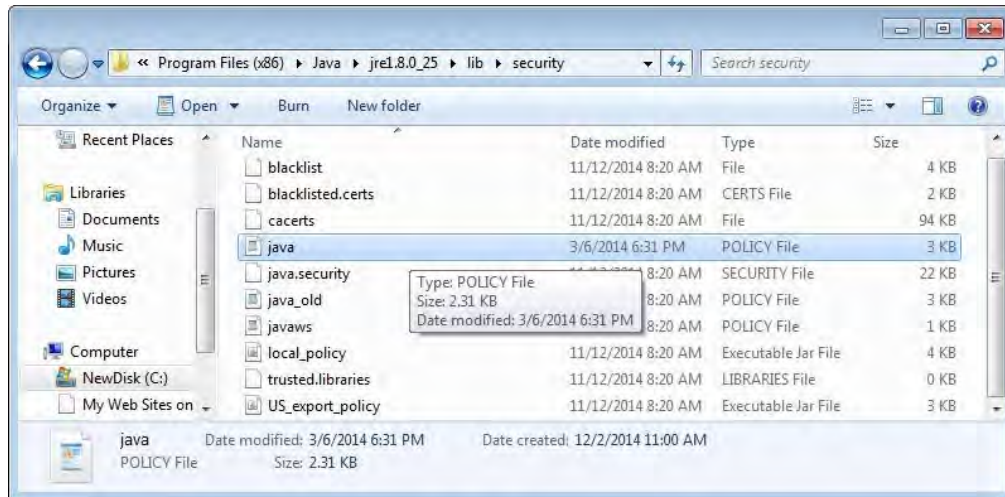

Figure 24: Java Policy Security Document Placement

**Creating a Java Security “Trusted” Site**

1. Locate the Java folder in the Programs listing.

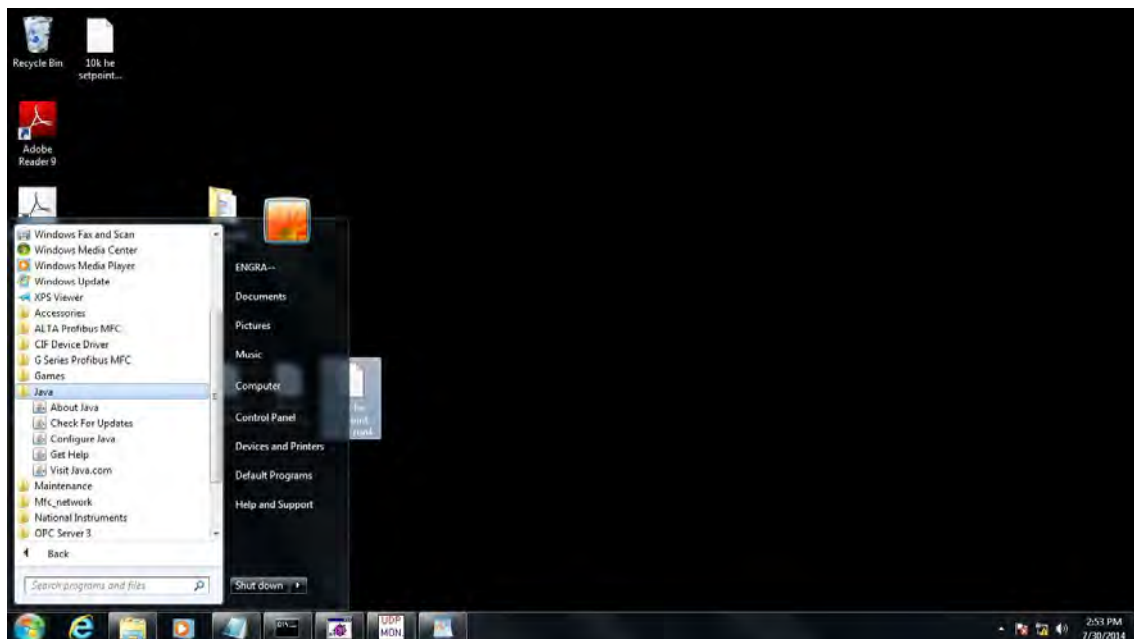

Figure 25: Java Folder

2. Select **Configure Java**.
3. Go to the Security tab.

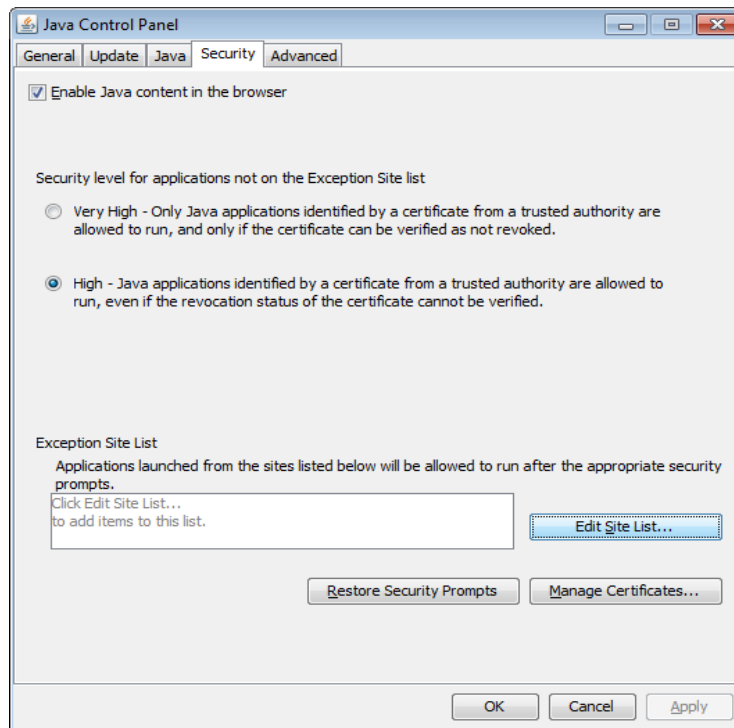

Figure 26: Java Control Panel - Security Tab

4. Click the **Edit Sites List** button.
5. Click **Add** and enter the IP address of the MFC. Click **OK** to save it to the Exception Site List.

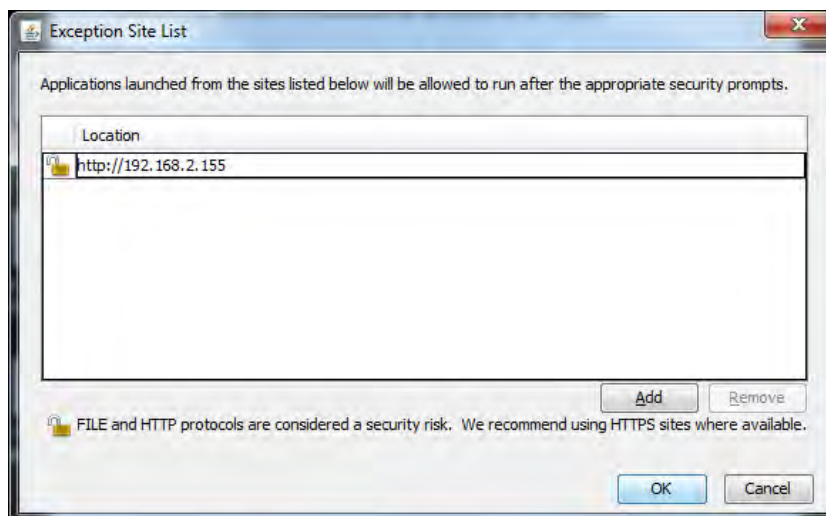

Figure 27: Exception Site List

- When you see a Security Warning, click **Continue** and then **OK** to close the Edit List window.

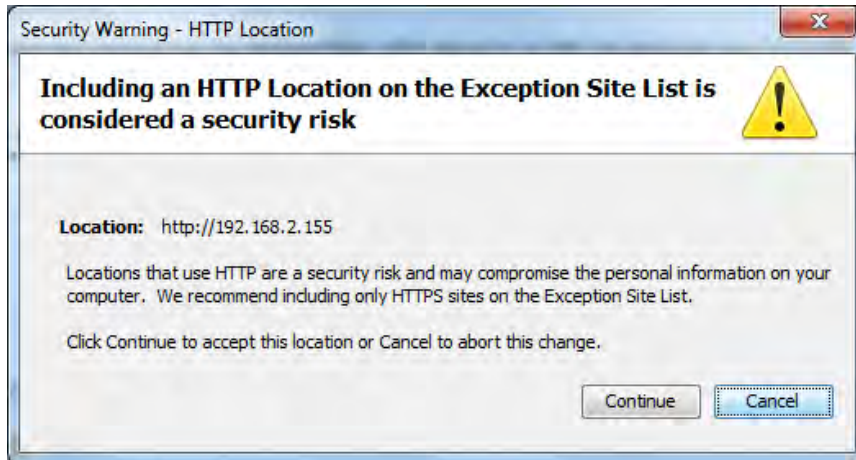

Figure 28: Security Warning

- Click **OK** to close the Security window.

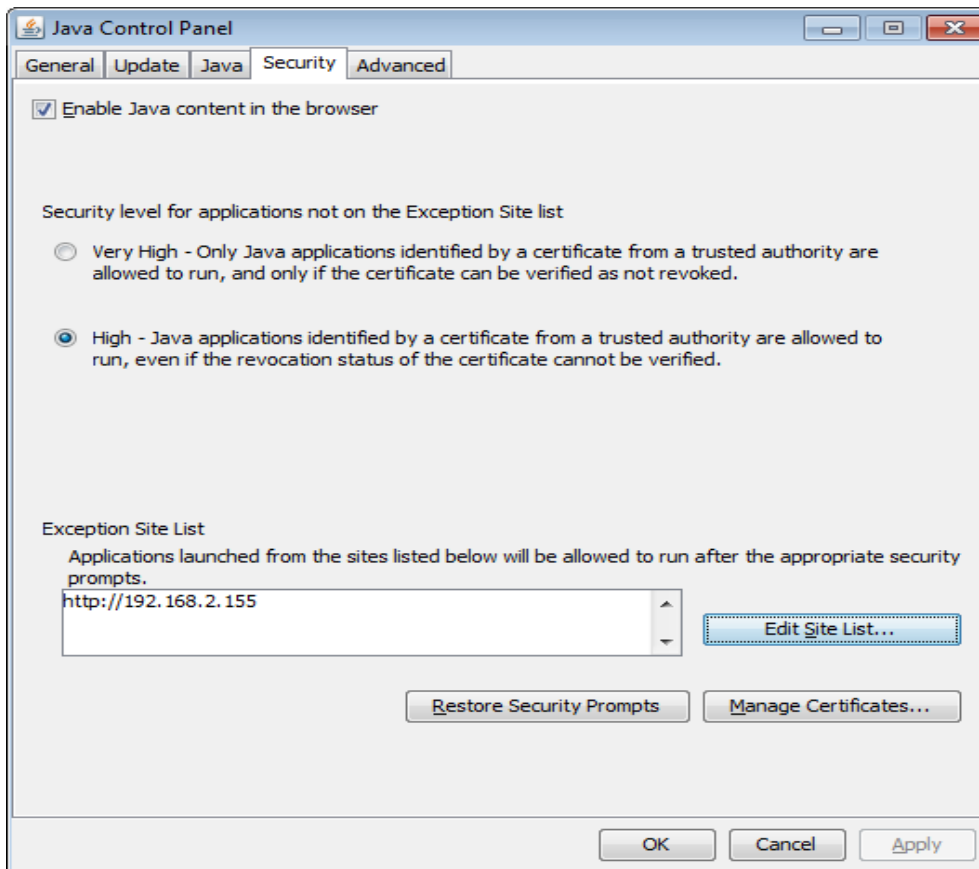

Figure 29: Security Window

**NOTE**

After completing all steps in this section, close the Web browser and re-launch Internet Explorer. Re-open the Web browser, select the Plot tab, and provide permission to run the Java applet for the Plot function.

If a security pop-up message denying access persists, close all applications and re-boot the computer before trying to open the Plot page of the Web browser.

8. Select the <Plot> tab.

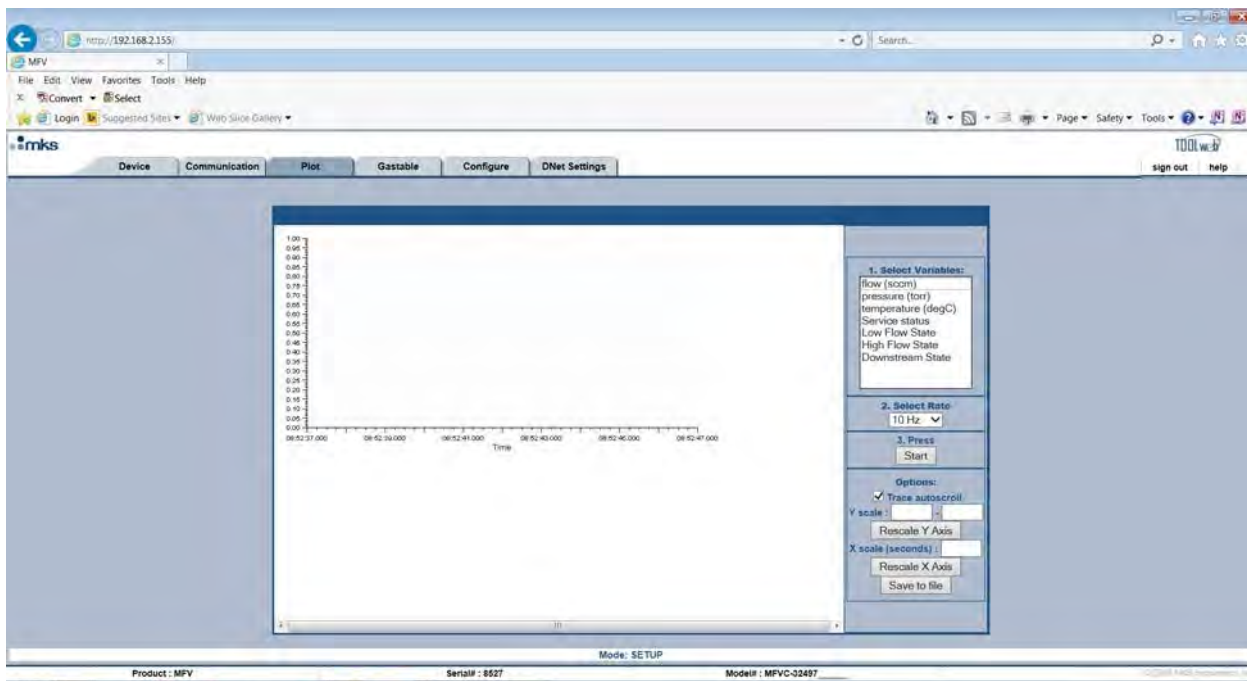

Figure 30: Plot Page

Variable selection, control parameters, and the ability to send a pressure set point to the GPC are available on the right side plot page.

9. Select appropriate variable and hit <Start>. Values for variables selected are displayed at the bottom of the plot screen.

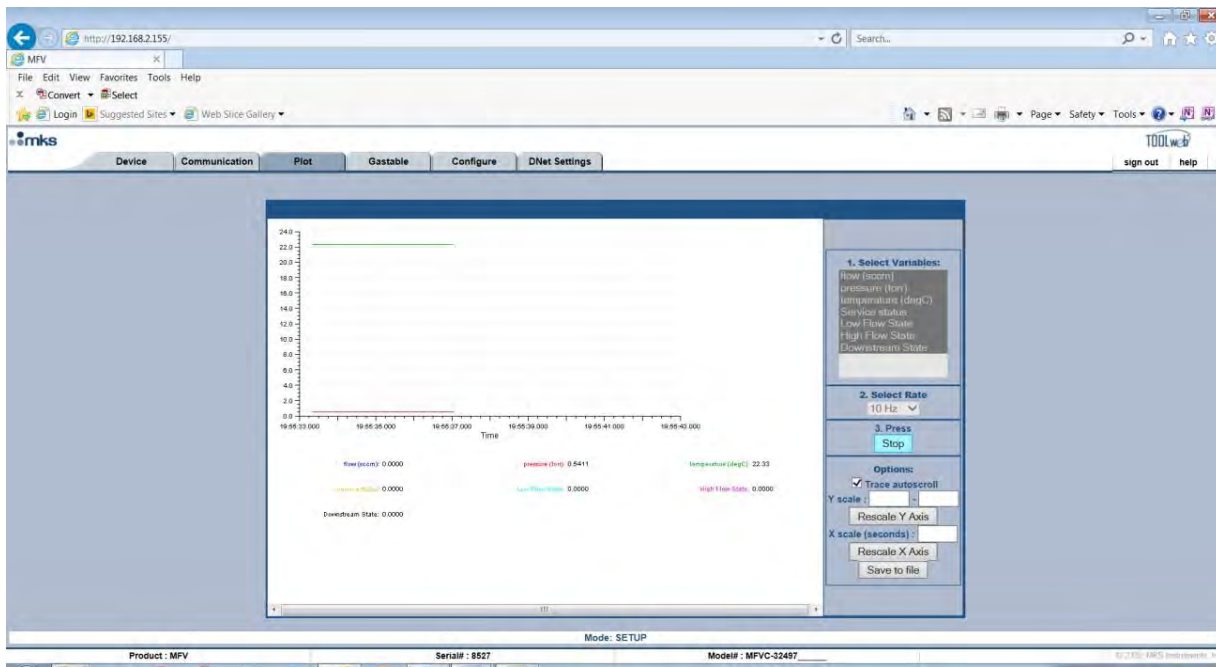

Figure 31: Variable Selection and Real Time Plot

10. Select Save File. Find ToolWeb Folder in C Drive. Assign a File name and hit save.

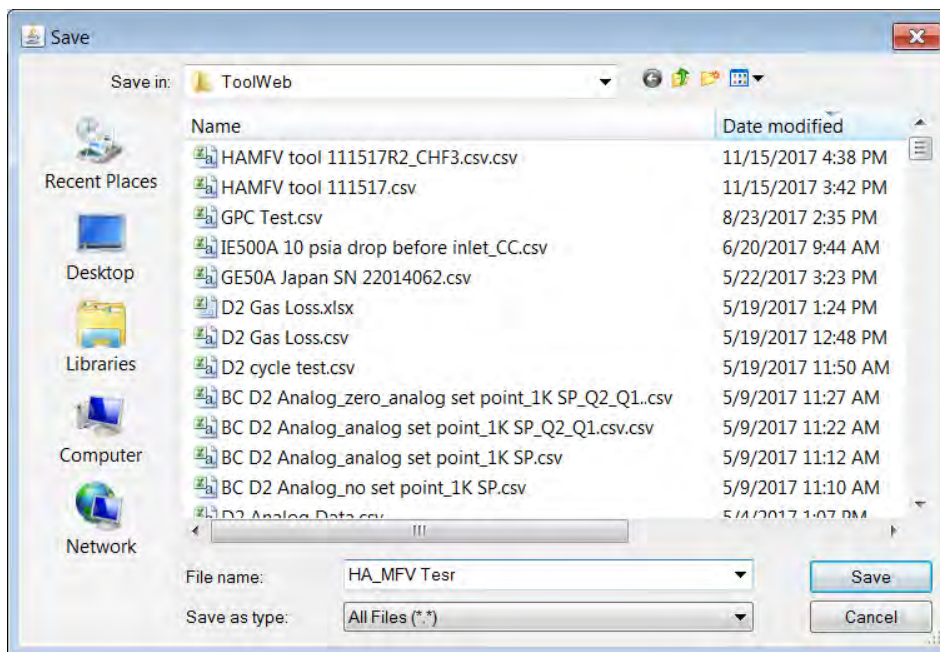

Figure 32: ToolWeb Folder to Save Data



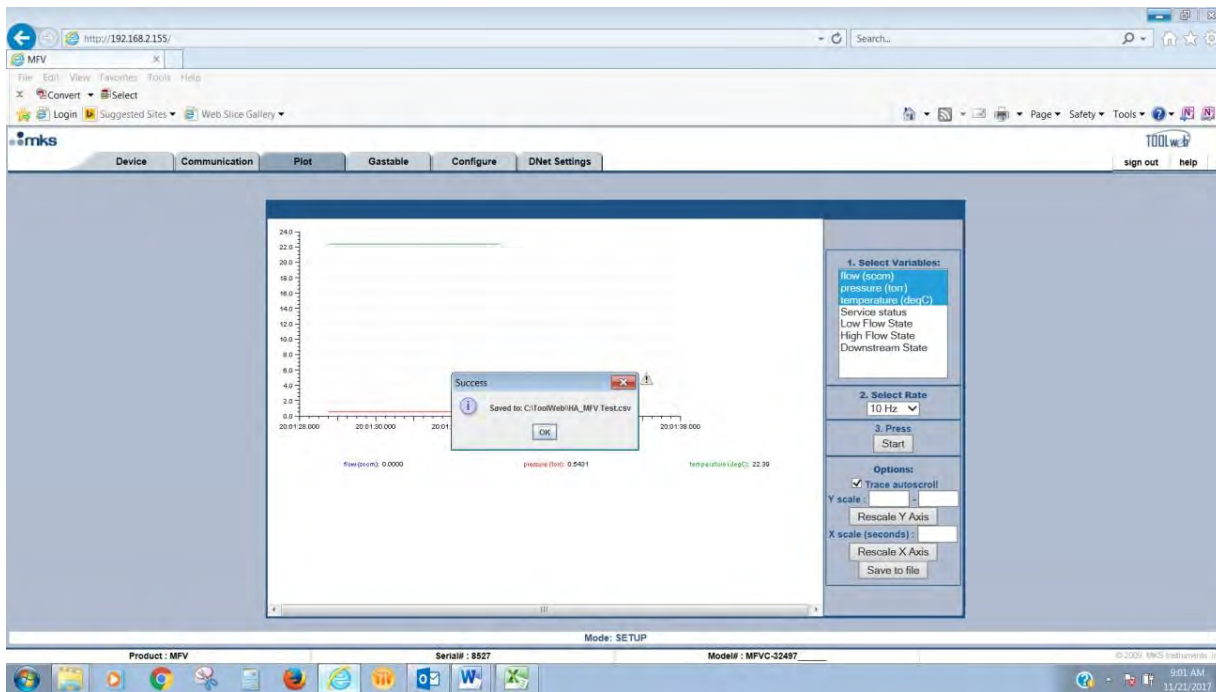

Figure 33: File Successfully Saved in ToolWeb Folder

## Appendix B HAMFV Operation Flow Charts: DeviceNet I/O

A series of flowcharts have been created for the common services to demonstrate the types of steps required in order to complete the service. In each case the appropriate device net explicit commands related to the HAMFV are derived and stated based upon the DeviceNet Profile Supplement.

### Flow Verification Service

**Verification Step**

- Verify MFV in Executing Mode
- Check valve status
- Set Stabilization Time
- Execute Verification Service
- Set MFC Flow rate
- Check Service Status
- Read MFV Flow
- Set MFC Flow = 0
- Purge Manifold
- Check valve status, isolate MFV prior to starting tool production

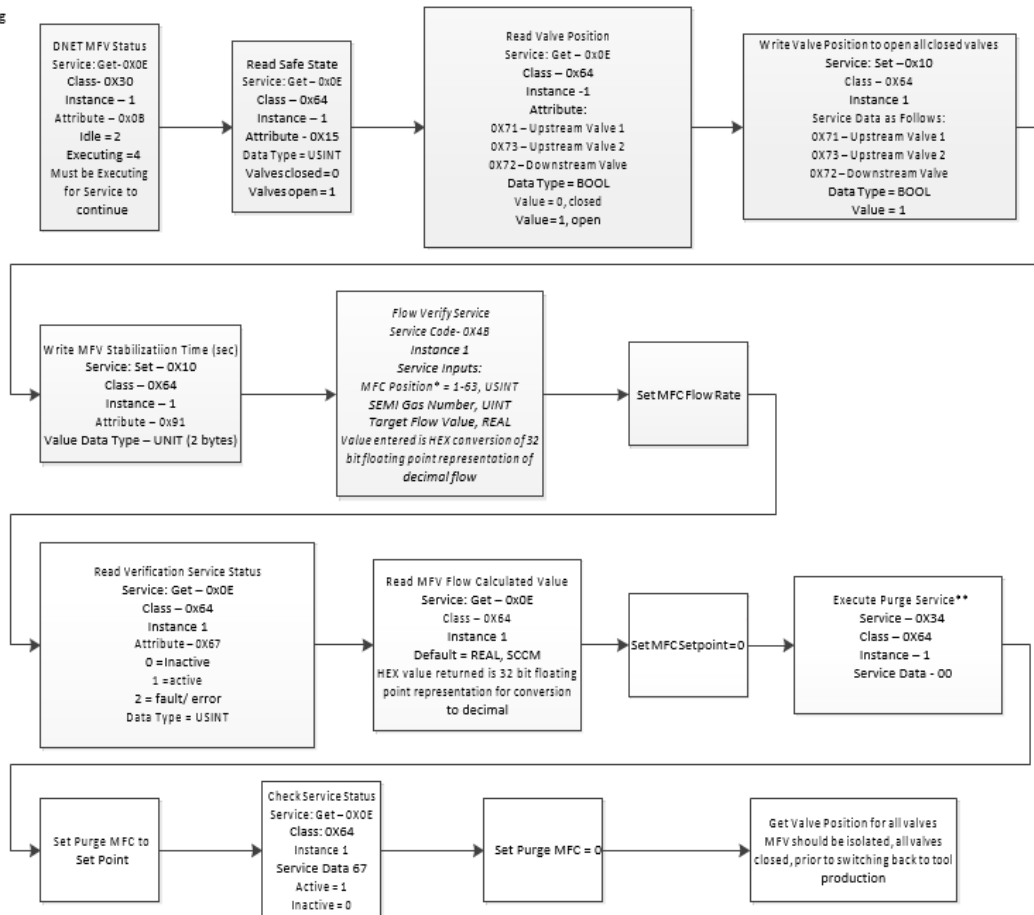

\* MFC Position is an input that is not supported, so always set value = 1

\*\* Length of purge service is determined by:  
 (Service Time Constant)\*(Number of Purge Cycles)= Total time in secs  
 See Manifold Purge Tab for additional information

Figure 34: File Flow Verification Service

## Zero Adjust Pressure Service

**Verification Step**

- MFV in OP Mode
- Read valve status, Verify all valves closed
- Open Downstream valve
- Monitor MFV pressure until stable @vacuum
- Execute Auto Zero Service
- Monitor Service in Progress Status
- Verify pressure zero
- Close downstream valve

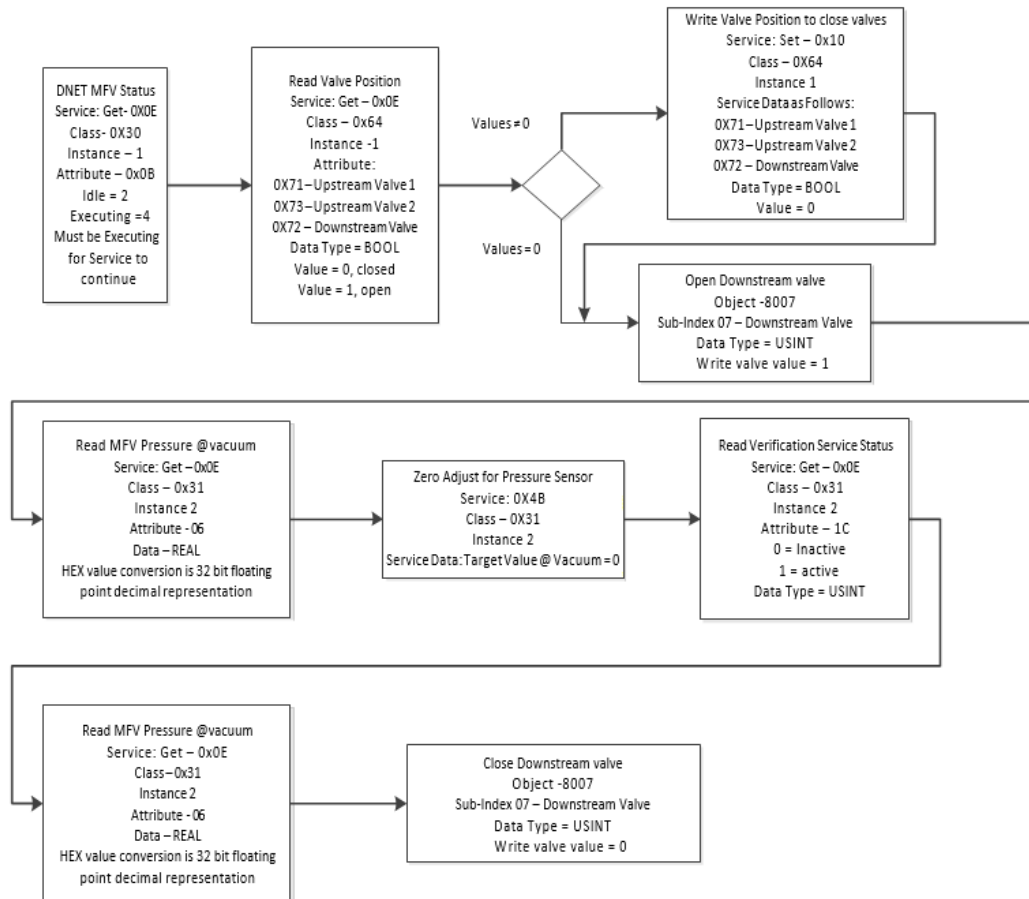

Figure 35: Zero Adjust Pressure Service

## Manifold Purge Service

**Verification Step**

- MFV in Executing Mode
- Set Service Time Constant
- Set # of Purge Cycles
- Execute Verifier Purge Service
- Set Purge MFC
- Monitor Manifold Purge Status, verify complete
- Set Purge MFC Set Point = 0
- Read Valve Positions
- Close all valves to isolate MFV

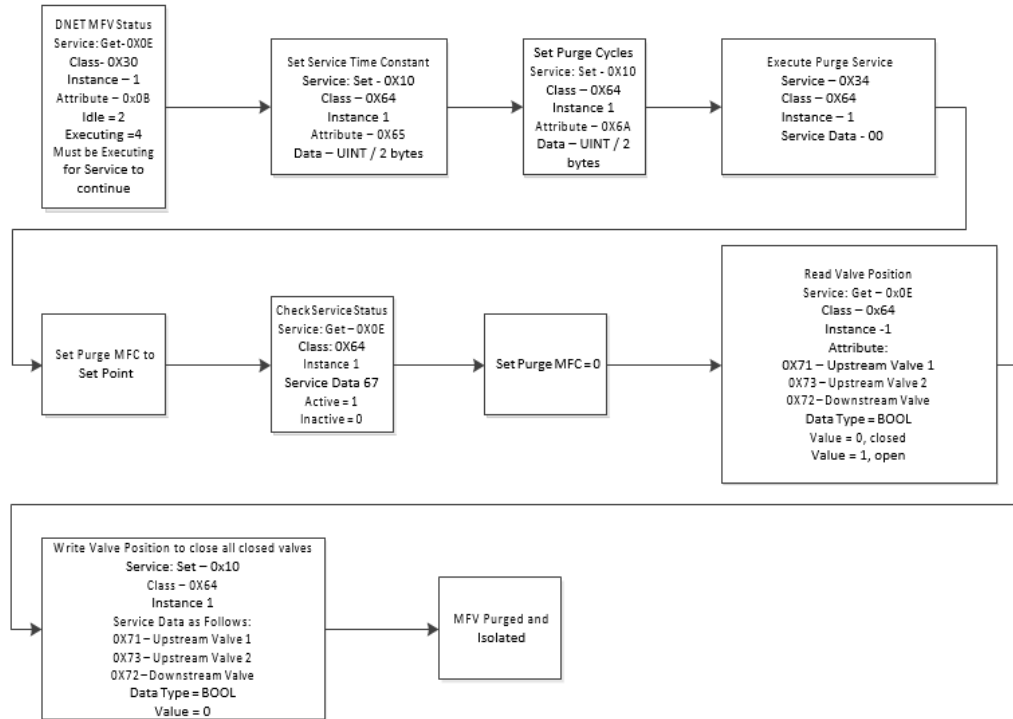

Figure 36: Manifold Purge Service

# Appendix C HAMFV Operation Flow Charts: Ethercat I/O

A series of flowcharts have been created for the common services to demonstrate the types of steps required in order to complete the service. In each case the appropriate Ethercat commands related to the HAMFV are derived and stated based upon the Ethercat Profile Supplement.

## Flow Verification Service

**Verification Step**

- MFV in OP Mode
- Set MFV Stabilization Time
- Check valve status
- Set MFV SEMI Gas Number
- Set MFV Flow Rate
- Set MFC Flow Rat
- Execute Verification Service
- Check Service Status
- Read MFV Flow
- Set MFC Flow = 0
- Check valve status, isolate MFV prior to starting tool production

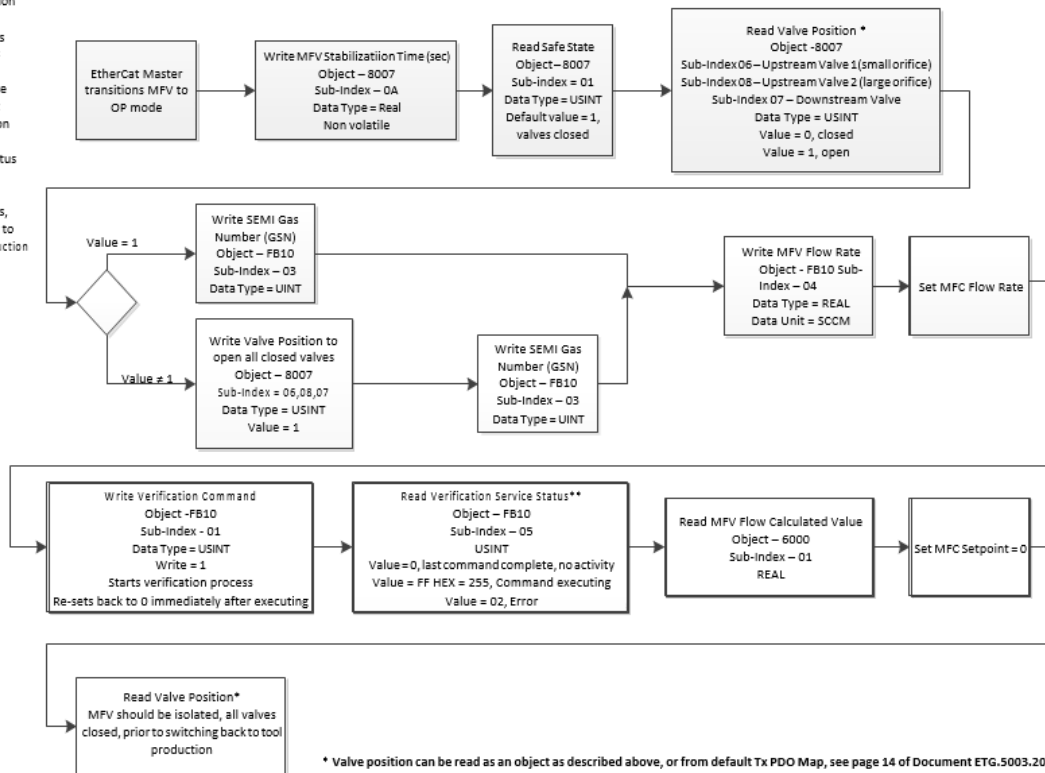

\* Valve position can be read as an object as described above, or from default Tx PDO Map, see page 14 of Document ETG.5003.20XX V0.0.2

\*\* Status can be indicated as follows:

- Verification Service Object as described above
- Service Status Object (Object - 600F, Sub-Index - 01), true if any service command is active
- Service Status Object as a default Tx PDO Map, see page 14 of Document ETG.5003.20XX V0.0.2

Note: This flow chart verification service is designed to begin verification with the valves in an open position. A verification service scenario would also be possible whereby the valves start in a closed position depending on the application

Figure 37: Flow Verification Service

## Pressure Zero Adjust Service

**Verification Step**

- MFV in OP Mode
- Read valve status, Verify all valves closed
- Open Downstream valve
- Monitor MFV pressure until stable @ vacuum
- Execute Auto Zero Service
- Monitor Service in Progress Status
- Verify pressure zero
- Close downstream valve

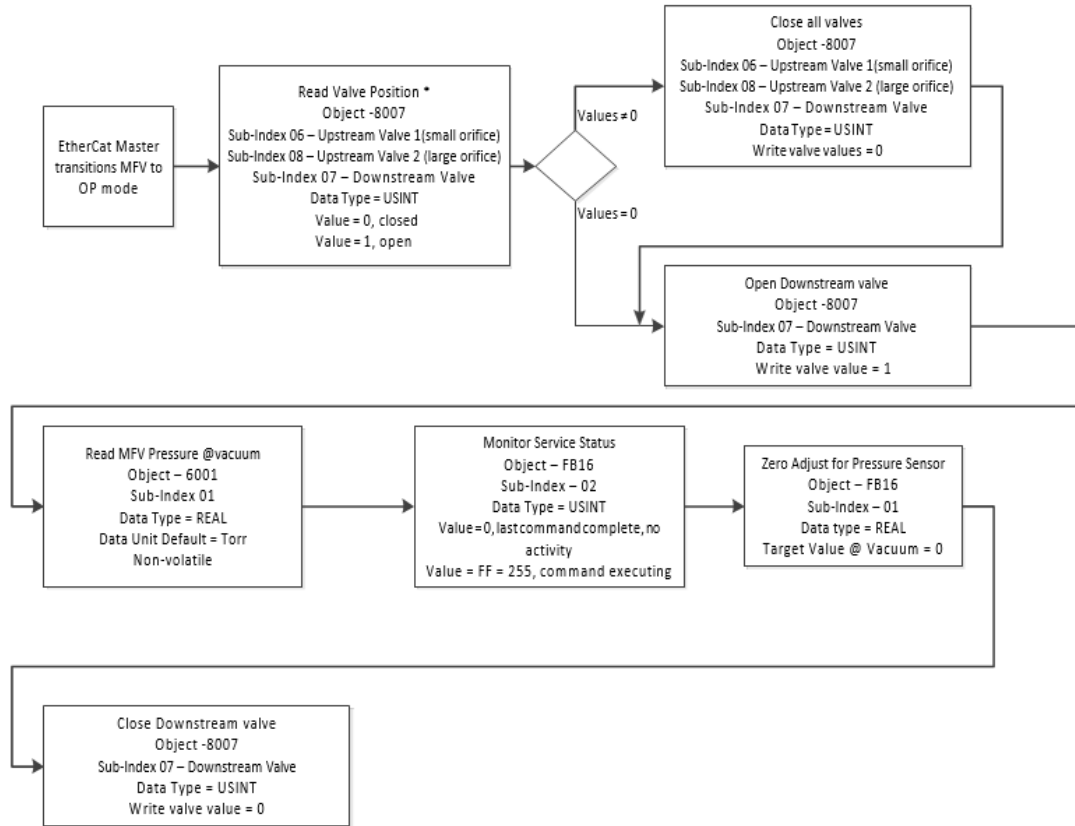

Figure 38: Pressure Zero Adjust Service

## Manifold Purge Service

**Verification Step**

- MFV in OP Mode
- Read Valve Positions
- Close All valves to isolate MFV
- Monitor Manifold Purge Status
- Set Purge MFC Set Point
- Execute Verifier Purge Service
- Read Valve positions (all open during service execution)
- Monitor Manifold Purge Status, verify complete
- Read valve positions to verify closed position
- Set Purge MFC Set Point = 0

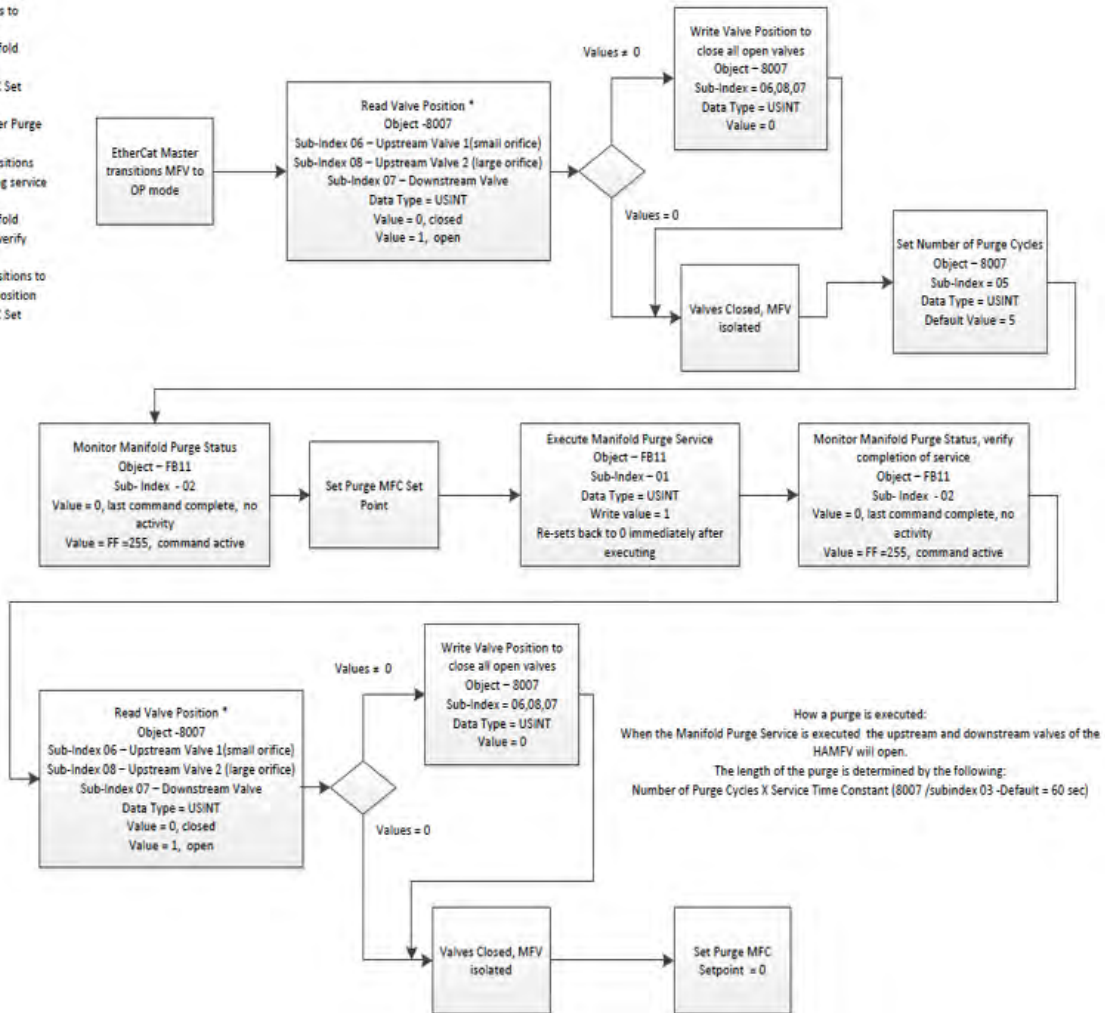

Figure 39: Manifold Purge Service

## MFV Device Leak Service

- Verification Step
- MFV in OP Mode
- Read Valve Positions
- Close All valves to isolate MFV
- Set MFV to PRE-OP Mode
- Set Service Time Constant
- Set MFV to OP Mode
- Read Valve positions and set valves to open
- Set Purge MFC set point to flow clean inert gas.
- Close MFV upstream valves
- Set Purge MFC Set Point = 0
- Pump MFV below 5T and close MFV Downstream valve
- Execute Leak Check Service
- Read Leak Check Results
- Isolate MFV

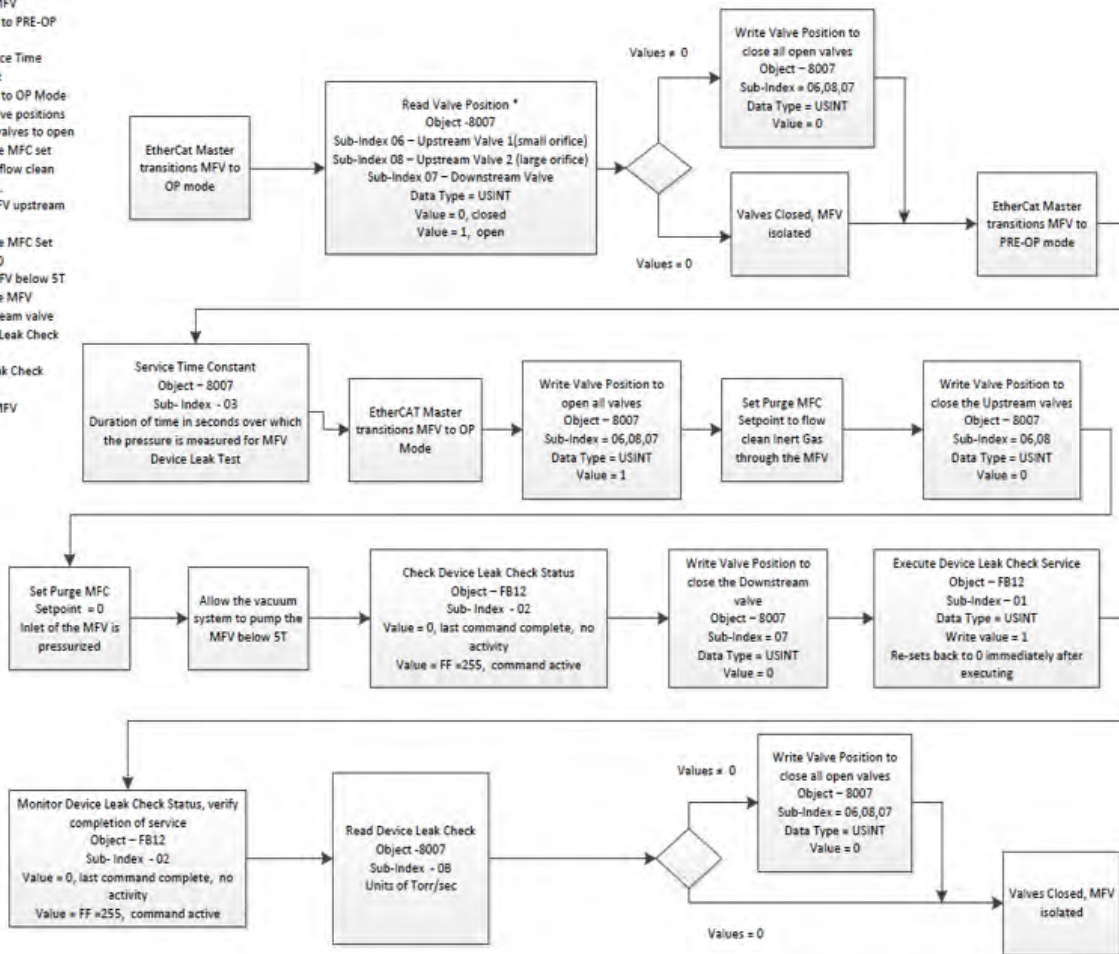

Figure 40: MFV Device Leak Service



## MFV System Leak Service

- Verification Step
- MFV in OP Mode
- Read Valve Positions
- Close All valves to isolate MFV
- Set MFV to PRE-OP Mode
- Set Service Time Constant
- Set MFV to OP Mode
- Read Valve positions and set valves to open
- Set MFC set point to flow gas.
- Close MFC upstream isolation valve
- Pump MFV below 5T and close MFV Downstream valve
- Execute System Check Service
- Read System Check Results
- Isolate MFV

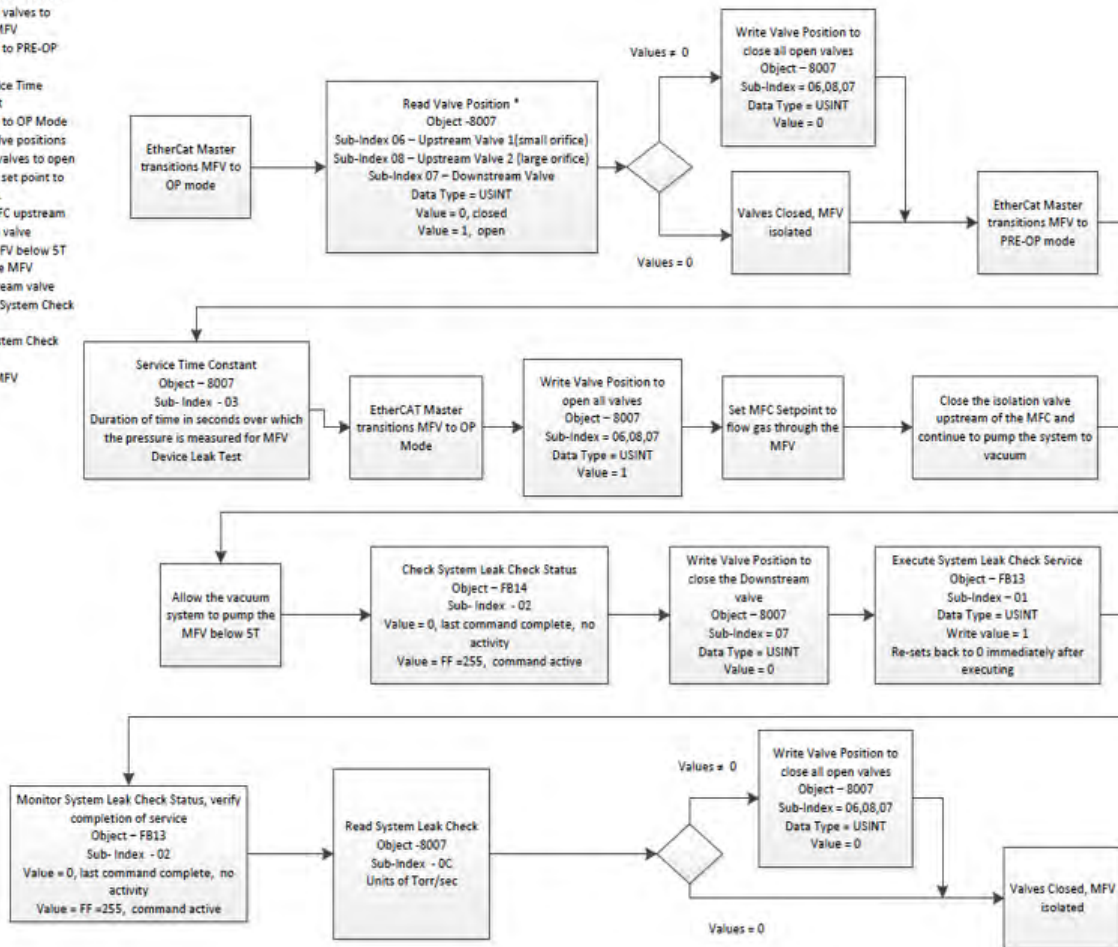

Figure 41: MFV System Leak Service